



**KAN-therm
MULTISYSTEM**

> 35 | év tapasztalat
a szerelési piacon



KAN-therm
Steel, Inox
Copper, Copper Gas

PROFIL V

INNOVATÍV VÍZ- ÉS FŰTÉSI
MEGOLDÁSOK

Install the **future**

Tartalomjegyzék

KAN-therm Steel rendszer V - termékválaszték	5
KAN-therm Inox rendszer V - termékválaszték	21
KAN-therm Copper rendszer V - termékválaszték	37
KAN-therm Copper rendszer V Gas - termékválaszték	46

Tyto obchodní informace jsou vázane od 01.03.2026. Dostupnost zboží podle individuálních ujednání.
Fotografie představující nabízené zboží slouží pouze pro informaci. Skutečné barevné a designové detaily prvků se mohou lišit od detailů uvedených na fotografiích. Od data zveřejnění nových informací, nejsou v platnosti staré informace týkající se stejného výrobku.
Společnost KAN si vyhrazuje právo tyto informace kdykoli doplnit, změnit nebo nahradit jinými obchodními informacemi.
© Copyright KAN Všechna práva vyhrazena. Text, grafika a grafické údaje v publikacích KAN jsou chráněny autorskými právy.



KAN-therm
MULTISYSTEM

> 35 | év tapasztalat
a szerelési piacon



KAN-therm

Steel V



TRADICIONÁLIS ALAPANYAG
EGY MODERN TECHNOLÓGIÁBAN

Install the **future**

Tartalomjegyzék

KAN-therm Steel rendszer V - termékválaszték

Csövek	5
Idomok	6
Kiegészítők	13
Szerszámok	15



O-gyűrű tömítés	Működési paraméterek	Alkalmazási terület
 EPDM (fekete)	<ul style="list-style-type: none">■ Üzemi hőmérséklet -20 °C – +110 °C,■ Maximális hőmérséklet +130 °C (rövid ideig)■ Maximális üzemi nyomás 16 bar	<ul style="list-style-type: none">■ Fűtőrendszerek■ Hűtőrendszerek 35%-ig terjedő glikoltartalommal■ Sűrített levegős rendszerek, 1. – 3. osztály az ISO 8573 szabványnak megfelelően, és inert gázok
 FPM (zöld)	<ul style="list-style-type: none">■ Üzemi hőmérséklet -20 °C – +180 °C■ Maximális hőmérséklet +230 °C (rövid ideig)■ Maximális üzemi nyomás 16 bar	<ul style="list-style-type: none">■ Napelemes rendszerek■ Víz-glikol keverék 50%-ig■ Dízel üzemanyagok■ Olajszállítás■ Vákuum (min 0,8 bar)■ Sűrített levegős rendszerek, 1. – 3. osztály az ISO 8573 szabványnak megfelelően, és inert gázok■ Nem alkalmas tiszta, forró vízhez (60 °C felett)

KAN-therm Steel rendszer V - termékválaszték

Csövek

Szénacél cső szálban

CSOPORT: J

Méret [m]	*	Kód			Egys.
12x1,2	**	1530207027	6	624	m
15x1,2	**	1530207028	6	1290	m
18x1,2	**	1530207029	6	1524	m
22x1,5	**	1530207030	6	1290	m
28x1,5	**	1530207031	6	624	m
35x1,5	**	1530207032	6	402	m
42x1,5	**	1530207033	6	402	m
54x1,5	**	1530207034	6	402	m



 tekerics  szál  köteg  csomag  papír doboz  raklap **N** új  hamarosan elérhető

* megrendelésre – átfutási idő max. 5 hét | ** egyéni egyeztetés alapján igényelhető | *** készlet erejéig

Idomok



Külső menetes csatlakozó

CSOPORT: I1

Méret [mm]	*	Kód			Egys.
12 R $\frac{3}{8}$ "	**	1562045000	5	200	db.
15 R $\frac{3}{8}$ "	**	1562045002	5	100	db.
15 R $\frac{1}{2}$ "	**	1562045001	5	150	db.
18 R $\frac{1}{2}$ "	**	1562045003	5	160	db.
18 R $\frac{3}{4}$ "	**	1562045004	5	100	db.
22 R $\frac{1}{2}$ "	**	1562045005	5	70	db.
22 R $\frac{3}{4}$ "	**	1562045006	5	100	db.
22 R1"	**	1562045007	5	60	db.
28 R $\frac{3}{4}$ "	**	1562045009	5	50	db.
28 R1"	**	1562045008	5	60	db.
35 R1 $\frac{1}{4}$ "	**	1562045010	5	40	db.
35 R1"	**	1562045013	10	40	db.
42 R1 $\frac{1}{4}$ "	**	1562045011	1	24	db.
54 R2"	**	1562045012	1	12	db.



Külső menetes hollandier toldattal

CSOPORT: I1

Méret [mm]	*	Kód			Egys.
15 R $\frac{1}{2}$ "	**	1562272000	5	50	db.
18 R $\frac{1}{2}$ "	**	1562272001	5	60	db.
22 R $\frac{3}{4}$ "	**	1562272002	5	40	db.
28 R1"	**	1562272003	5	30	db.
35 R1 $\frac{1}{4}$ "	**	1562272004	5	15	db.
42 R1 $\frac{1}{2}$ "	**	1562272005	1	12	db.
54 R2"	**	1562272006	1	4	db.

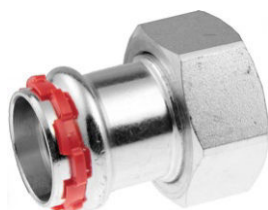

Belső menetes félhollandier tomitógyűrűvel

CSOPORT: I1



Méret [mm]	*	Kód			Egys.
18 G $\frac{3}{4}$ "	**	1562106000	5	100	db.
22 G1"	**	1562106001	5	60	db.
28 G1 $\frac{1}{4}$ "	**	1562106002	5	40	db.
35 G1 $\frac{1}{2}$ "	**	1562106003	4	32	db.
42 G1 $\frac{3}{4}$ "	**	1562106004	4	12	db.

tekercs szál köteg csomag papír doboz raklap **N** új hamarosan elérhető

* megrendelésre – átfutási idő max. 5 hét | ** egyéni egyeztetés alapján igényelhető | *** készlet erejéig

Belső menetes hollander toldattal

CSOPORT: I1

Méret [mm]	*	Kód			Egys.
15 Rp1/2"	**	1562119000	5	60	db.
18 Rp1/2"	**	1562119001	5	40	db.
22 Rp3/4"	**	1562119002	5	40	db.
28 Rp1"	**	1562119003	5	25	db.
35 Rp1 1/4"	**	1562119004	5	20	db.
42 Rp1 1/2"	**	1562119005	1	8	db.
54 Rp2"	**	1562119006	1	4	db.



Belső menetes csatlakozó



CSOPORT: I1

Méret [mm]	*	Kód			Egys.
15 Rp1/2"	**	1562044000	5	130	db.
18 Rp1/2"	**	1562044001	5	120	db.
18 Rp3/4"	**	1562044002	5	80	db.
22 Rp3/4"	**	1562044003	5	100	db.
28 Rp1/2"	**	1562044004	5	40	db.
28 Rp1"	**	1562044005	5	60	db.
28 Rp3/4"	**	1562044006	5	40	db.
35 Rp1 1/4"	**	1562044007	5	30	db.
22 Rp1/2"	**	1562044008	10	100	db.
35 Rp1"	**	1562044009	10	40	db.
42 Rp1 1/2"	**	1562044010	4	24	db.
54 Rp2"	**	1562044011	4	12	db.



Belső menetes csatlakozó áttoló véggel



CSOPORT: I1

Méret [mm]	*	Kód			Egys.
12 Rp1/2"	**	1562076001	10	150	db.
15 Rp1/2"	**	1562076002	5	125	db.
18 Rp1/2"	**	1562076003	5	125	db.
18 Rp3/4"	**	1562076004	5	100	db.
22 Rp1/2"	**	1562076005	5	70	db.
22 Rp3/4"	**	1562076006	5	80	db.



Karmantyú

CSOPORT: I1

Méret [mm]	*	Kód			Egys.
12	**	1562245000	10	160	db.
15	**	1562245001	10	140	db.
18	**	1562245002	10	140	db.
22	**	1562245003	10	80	db.
28	**	1562245004	5	60	db.
35	**	1562245005	5	40	db.
42	**	1562245006	1	20	db.
54	**	1562245007	1	15	db.



 tekercs  szál  köteg  csomag  papír doboz  raklap  új  hamarosan elérhető

* megrendelésre – átfutási idő max. 5 hét | ** egyéni egyeztetés alapján igényelhető | *** készlet erejéig



Áttoló karmantyú

CSOPORT: I1

Méret [mm]	*	Kód			Egys.
15	**	1562080000	5	140	db.
18	**	1562080001	5	100	db.
22	**	1562080002	5	60	db.
28	**	1562080003	5	40	db.
35	**	1562080004	5	20	db.
42	**	1562080005	1	15	db.
54	**	1562080006	1	8	db.



Könyökidom, 90°

CSOPORT: I1

Méret [mm]	*	Kód			Egys.
12	**	1562302000	10	180	db.
15	**	1562302001	10	150	db.
18	**	1562302002	10	90	db.
22	**	1562302003	10	60	db.
28	**	1562302004	5	30	db.
35	**	1562302005	5	20	db.
42	**	1562302006	1	8	db.
54	**	1562302007	1	8	db.



KB könyök, 90°

CSOPORT: I1

Méret [mm]	*	Kód			Egys.
12	**	1562326000	10	150	db.
15	**	1562326001	10	120	db.
18	**	1562326002	10	60	db.
22	**	1562326003	10	60	db.
28	**	1562326004	5	30	db.
35	**	1562326005	5	10	db.
42	**	1562326006	1	8	db.
54	**	1562326007	1	6	db.



Könyökidom, 45°

CSOPORT: I1



Méret [mm]	*	Kód			Egys.
15	**	1562303000	10	150	db.
18	**	1562303001	10	120	db.
22	**	1562303002	10	70	db.
28	**	1562303003	5	40	db.
35	**	1562303004	5	25	db.
42	**	1562303005	1	16	db.
54	**	1562303006	1	8	db.

tekercs
 szál
 köteg
 csomag
 papír doboz
 raklap
 új
 hamarosan elérhető

* megrendelésre – átfutási idő max. 5 hét | ** egyéni egyeztetés alapján igényelhető | *** készlet erejéig

KB könyökidom, 45°



CSOPORT: I1

Méret [mm]	*	Kód			Egys.
15	**	1562325000	10	150	db.
18	**	1562325001	10	120	db.
22	**	1562325002	10	60	db.
28	**	1562325003	5	40	db.
35	**	1562325004	5	25	db.
42	**	1562325005	1	16	db.
54	**	1562325006	1	8	db.



T-idom



CSOPORT: I1

Méret [mm]	*	Kód			Egys.
15	**	1562257000	10	80	db.
18	**	1562257001	10	40	db.
22	**	1562257002	10	40	db.
28	**	1562257003	5	25	db.
35	**	1562257004	5	15	db.
42	**	1562257005	1	8	db.
54	**	1562257006	1	6	db.



Szűkített T-idom

CSOPORT: I1

Méret [mm]	*	Kód			Egys.
15 / 18 / 15	**	1562260000	5	60	db.
18 / 15 / 18	**	1562260001	10	60	db.
22 / 15 / 22	**	1562260002	10	50	db.
22 / 18 / 22	**	1562260003	10	50	db.
22 / 28 / 22	**	1562260004	10	40	db.
28 / 15 / 28	**	1562260005	5	30	db.
28 / 18 / 28	**	1562260006	5	30	db.
28 / 22 / 28	**	1562260007	5	30	db.
35 / 15 / 35	**	1562260008	5	20	db.
35 / 18 / 35	**	1562260009	5	20	db.
35 / 22 / 35	**	1562260010	5	20	db.
35 / 28 / 35	**	1562260011	5	20	db.
42 / 22 / 42	**	1562260012	1	12	db.
42 / 28 / 42	**	1562260013	1	12	db.
42 / 35 / 42	**	1562260014	1	12	db.
54 / 22 / 54	**	1562260015	1	8	db.
54 / 28 / 54	**	1562260016	1	8	db.
54 / 35 / 54	**	1562260017	1	8	db.
54 / 42 / 54	**	1562260018	1	8	db.



 tekercs
  szál
  köteg
  csomag
  papír doboz
  raklap
  új
  hamarosan elérhető

* megrendelésre – átfutási idő max. 5 hét | ** egyéni egyeztetés alapján igényelhető | *** készlet erejéig



Szűkített T-idom (M-V-M)

CSOPORT: I1

Méret [mm]	*	Kód			Egys.
76,1 / 42 / 76,1	**	1562260019	2	-	db.
76,1 / 54 / 76,1	**	1562260020	2	-	db.
88,9 / 42 / 88,9	**	1562260021	2	-	db.
88,9 / 54 / 88,9	**	1562260022	2	-	db.
108 / 42 / 108	**	1562260023	2	-	db.
108 / 54 / 108	**	1562260024	2	-	db.



Szűkítő idom

CSOPORT: I1

Méret [mm]	*	Kód			Egys.
15 / 12	**	1562221000	10	200	db.
18 / 12	**	1562221001	10	200	db.
18 / 15	**	1562221002	10	200	db.
22 / 15	**	1562221003	10	140	db.
22 / 18	**	1562221004	10	120	db.
28 / 15	**	1562221005	5	70	db.
28 / 18	**	1562221006	10	100	db.
28 / 22	**	1562221007	10	80	db.
35 / 22	**	1562221008	5	50	db.
35 / 28	**	1562221009	1	35	db.
42 / 22	**	1562221010	1	25	db.
42 / 28	**	1562221011	1	24	db.
42 / 35	**	1562221012	1	20	db.
54 / 22	**	1562221013	1	16	db.
54 / 28	**	1562221014	1	16	db.
54 / 35	**	1562221015	1	16	db.
54 / 42	**	1562221016	1	16	db.
66.7 / 54	**	1562221017	2	4	db.
76.1 / 42	**	1562221018	4	4	db.
76.1 / 54	**	1562221019	4	4	db.
88.9 / 54	**	1562221020	4	4	db.



Külső menetes könyökidom, 90°

CSOPORT: I1



Méret [mm]	*	Kód			Egys.
12 R $\frac{3}{8}$ "	**	1562070000	5	100	db.
15 R $\frac{1}{2}$ "	**	1562070001	5	80	db.
15 R $\frac{3}{8}$ "	**	1562070002	5	80	db.
18 R $\frac{1}{2}$ "	**	1562070003	5	80	db.
22 R $\frac{3}{4}$ "	**	1562070004	5	60	db.
28 R1"	**	1562070005	5	30	db.
35 R1 $\frac{1}{4}$ "	**	1562070006	5	20	db.
42 R1 $\frac{1}{2}$ "	**	1562070007	1	10	db.

tekercs
 szál
 köteg
 csomag
 papír doboz
 raklap
 új
 hamarosan elérhető

* megrendelésre – átfutási idő max. 5 hét | ** egyéni egyeztetés alapján igényelhető | *** készlet erejéig

Külső menetes könyökidom, 90°, rövid



CSOPORT: I1

Méret [mm]	*	Kód			Egys.
15 R $\frac{3}{8}$ "	**	1562070008	10	100	db.
15 R $\frac{1}{2}$ "	**	1562070009	10	80	db.
18 R $\frac{1}{2}$ "	**	1562070010	10	80	db.
22 R $\frac{3}{4}$ "	**	1562070011	10	60	db.



Belső menetes könyökidom, 90°

CSOPORT: I1

Méret [mm]	*	Kód			Egys.
15 Rp $\frac{1}{2}$ "	**	1562069000	5	80	db.
18 Rp $\frac{1}{2}$ "	**	1562069001	5	90	db.
22 Rp $\frac{3}{4}$ "	**	1562069002	5	50	db.
28 Rp1"	**	1562069003	5	30	db.



Belső menetes T-idom



CSOPORT: I1

Méret [mm]	*	Kód			Egys.
15 Rp $\frac{1}{2}$ "	**	1562258000	5	70	db.
18 Rp $\frac{1}{2}$ "	**	1562258001	5	50	db.
22 Rp $\frac{1}{2}$ "	**	1562258002	5	40	db.
22 Rp $\frac{3}{4}$ "	**	1562258003	5	40	db.
28 Rp $\frac{1}{2}$ "	**	1562258004	5	30	db.
28 Rp $\frac{3}{4}$ "	**	1562258005	5	30	db.
35 Rp $\frac{1}{2}$ "	**	1562258006	5	20	db.
35 Rp $\frac{3}{4}$ "	**	1562258007	5	20	db.
42 Rp $\frac{1}{2}$ "	**	1562258008	1	14	db.
42 Rp $\frac{3}{4}$ "	**	1562258009	1	12	db.
54 Rp $\frac{1}{2}$ "	**	1562258010	1	8	db.
54 Rp $\frac{3}{4}$ "	**	1562258011	2	8	db.



Kerülő idom

CSOPORT: I



Méret [mm]	*	Kód			Egys.
12	**	1509178000	10	80	db.
15	**	1509022005	10	70	db.
18	**	1509022006	10	60	db.
22	**	1509022007	10	40	db.
28	**	1509022008	5	20	db.





Hajlított csőív 90°



CSOPORT: I

Méret [mm]	*	Kód			Egys.
12	**	1509011000	10	80	db.
15	**	1509011002	10	70	db.
18	**	1509011003	10	50	db.
22	**	1509011004	10	30	db.
28	**	1509011005	5	20	db.
35	**	1509011007	2	8	db.
42	**	1509011008	2	4	db.
54	**	1509011009	2	10	db.



Végdugó

CSOPORT: I1



Méret [mm]	*	Kód			Egys.
15	**	1562250000	10	160	db.
18	**	1562250001	10	300	db.
22	**	1562250002	10	150	db.
28	**	1562250003	5	130	db.
35	**	1562250004	1	60	db.
42	**	1562250005	1	40	db.
54	**	1562250006	1	24	db.

 tekercs
  szál
  köteg
  csomag
  papír doboz
  raklap
  új
  hamarosan elérhető

* megrendelésre – átfutási idő max. 5 hét | ** egyéni egyeztetés alapján igényelhető | *** készlet erejéig

Kiegészítők

Bedugható végű átmeneti idom acélcsőhöz (hegeszthető toldat) CSOPORT: I1

Méret [mm]	*	Kód			Egys.
15 / 17	**	1562040000	5	30	db.
18 / 20	**	1562040001	5	30	db.
22 / 24	**	1562040002	5	40	db.
28 / 31	**	1562040003	5	40	db.
35 / 38	**	1562040004	5	30	db.
42 / 44.5	**	1562040005	5	15	db.
54 / 57	**	1562040006	1	8	db.





Megjegyzés:

A préselt kötés létrehozása előtt (az idom felhelyezése a tömítő O-gyűrűvel) a többretegű csövet hegeszteni kell, majd hagyni kell lehűlni. Ezzel elkerülhető a présidomon található tömítőelem károsodása.

EPDM lapos tömítés hollanderes idomhoz (fekete)

CSOPORT: I

Méret [mm]	*	Kód			Egys.
15-18	**	1562237000	20	500	db.
22	**	1562237001	20	500	db.
28	**	1562237002	20	400	db.
35	**	1562237003	20	400	db.
42	**	1562237004	20	300	db.
54	**	1562237005	20	300	db.





Megjegyzés:

A tömítés kizárólag KAN-therm Steel vagy KAN-therm Inox jelöléssel ellátott idomokhoz használható.

O-gyűrű, LBP EPDM

CSOPORT: P1



Méret [mm]	*	Kód			Egys.
12	**	2261182000	20	1000	db.
15	**	2261182001	20	600	db.
18	**	2261182002	20	500	db.
22	**	2261182003	20	500	db.
28	**	2261182004	20	400	db.
35	**	2261182005	20	400	db.
42	**	1562182000	20	300	db.
54	**	1562182001	20	300	db.





O-gyűrű, LBP FPM

CSOPORT: P1

Méret [mm]	*	Kód			Egys.
15	**	2260182000	20	600	db.
18	**	2260182001	20	500	db.
22	**	2260182002	20	500	db.
28	**	2260182003	20	400	db.
35	**	2260182004	20	400	db.
42	**	1562182002	20	300	db.
54	**	1562182003	20	300	db.

 tekerics  szál  kötég  csomag  papír doboz  raklap **N** új  hamarosan elérhető

* megrendelésre – átfutási idő max. 5 hét | ** egyéni egyeztetés alapján igényelhető | *** készlet erejéig

Szerszámok

Görgős csóvágó REMS RAS St

CSOPORT: K

Méret [mm]	*	Kód		Egys.
12-54	**	1948267025	1	db.
35-108	**	1948267027	1	db.



Csóvágógép REMS Cento

CSOPORT: K

Méret [mm]	*	Kód		Egys.
22-108	**	1948183001	1	db.

Megjegyzés:

A készlet tartalmaz egy csóvágó eszközt és egy vágókereket.



Sorjázó fém csőhöz REMS REG

CSOPORT: K

Méret [mm]	*	Kód			Egys.
12-54	**	1948267015	1	6	db.



REMS Power-Press ACC elektromos préselő szerző

CSOPORT: K

Méret [mm]	*	Kód			Egys.
12-54	**	1936267219	1	1	db.

Megjegyzés:

A préselő szerző dobozzal kapható.
A készlet nem tartalmazza a pófákat.



REMS Power-Press SE Basic Pack elektromos préselő szerző

CSOPORT: K

Méret [mm]	*	Kód		Egys.
12-54	**	1936267160	1	db.

Megjegyzés:

A présőgép kofferben kerül értékesítésre.
A készlet nem tartalmazza a pófákat.



REMS Akku-Press akkumulátoros préselő szerző

CSOPORT: K

Méret [mm]	*	Kód		Egys.
12-54	**	1936267152	1	db.

Megjegyzés:

A préselő szerző akkumulátorral, töltővel és dobozzal kapható.
A készlet nem tartalmazza a pófákat.



 tekercs  szál  köteg  csomag  papír doboz  raklap  új  hamarosan elérhető

* megrendelésre – átfutási idő max. 5 hét | ** egyéni egyeztetés alapján igényelhető | *** készlet erejéig



REMS "V" profilos préselő pófák

CSOPORT: K

Méret [mm]	*	Kód			Egys.
12	**	1948267173	1	48	db.
15	**	1948267174	1	500	db.
18	**	1948267175	1	500	db.
22	**	1948267176	1	500	db.
28	**	1948267177	1	500	db.
35	**	1948267178	1	48	db.
42	**	1948267179	1	200	db.
54	**	1948267180	1	48	db.

Megjegyzés:

A szorítópófák Power-Press SE, Akku-Press és Power-Press ACC préselőgépekkel kompatibilisek.



Novopress szerszámkészlet - ACO103 BT akkumulátoros préselő szerszám + „V” profilos pófák

CSOPORT: K

Méret [mm]	*	Kód		Egys.
15-28	**	1948055009	10	db.

Mindegyik készlet tartalma:

- Akkumulátoros préselő szerszám - 1 db.,
- 1948267168 - V15 pófák préselő szerszámhoz - 1 db.,
- 1948267169 - V18 pófák préselő szerszámhoz - 1 db.,
- 1948267170 - V22 pófák préselő szerszámhoz - 1 db.,
- 1948267171 - V28 pófák préselő szerszámhoz - 1 db.,
- 1938267047 - Akkumulátortöltő - 1 db.,
- 1938267002 - 2 Ah akkumulátor - 2 db.,
- Doboz - 1 db.



Novopress PB1 "V" profilos préselő pófák

CSOPORT: K

Méret [mm]	*	Kód			Egys.
12	**	1948267167	1	500	db.
35	**	1948267172	1	320	db.

Megjegyzés:

A szorítópófák ACO103 préselőgépekkel kompatibilisek.



Novopress ACO203XL BT préselő szerszám

CSOPORT: K

Méret [mm]	*	Kód		Egys.
12-108	**	1948267181	1	db.

Mindegyik készlet tartalma:

- akkumulátoros préselő szerszám - 1 db.,
- milwaukee 18 V / 5,0 Ah Li -ion akkumulátor - 2 db.,
- akkumulátortöltő - 1 db.,
- kenőanyag - 1 db.,
- műanyag doboz.



Novopress EFP203 elektromos préselő szerszám

CSOPORT: K

Méret [mm]	*	Kód		Egys.
12-54	**	1948267210	1	db.

Megjegyzés:



A préselő szerszám műanyag dobozzal kapható.

tekerics szál köteg csomag papír doboz raklap új hamarosan elérhető

* megrendelés – átfutási idő max. 5 hét | ** egyéni egyeztetés alapján igényelhető | *** készlet erejéig

Novopress PB2 "V" profilos préselő pófák

CSOPORT: K

Méret [mm]	*	Kód			Egys.
12	**	1948267211	1	500	db.
15	**	1948267212	1	500	db.
18	**	1948267213	1	500	db.
22	**	1948267214	1	500	db.
28	**	1948267215	1	500	db.
35	**	1948267216	1	500	db.
42	**	1948267217	1	100	db.
54	**	1948267218	1	100	db.



Megjegyzés:

A pófák EFP203 és ACO203XL hajtóegységekkel használhatók.

Novopress "V" profilos rápattintható karmantyú

CSOPORT: K

Méret [mm]	*	Kód			Egys.
42	**	1905267015	1	100	db.
54	**	1905267016	1	100	db.



Megjegyzés:

A 42 - 54 mm átmérőjű prés pófákat a ZB203 adapterrel használja.
A pófák EFP203 és ACO203XL hajtóegységekkel használhatók.

Novopress ZB203 adapter

CSOPORT: K

Méret [mm]	*	Kód		Egys.
42-54	**	1948267000	1	db.

Megjegyzés:

Adapter EFP203 és ACO203XL hajtóegységekhez.



 tekercs  szál  köteg  csomag  papír doboz  raklap  új  hamarosan elérhető

* megrendelésre – átfutási idő max. 5 hét | ** egyéni egyeztetés alapján igényelhető | *** készlet erejéig



KAN-therm
MULTISYSTEM

> 35 | év tapasztalat
a szerelési piacon

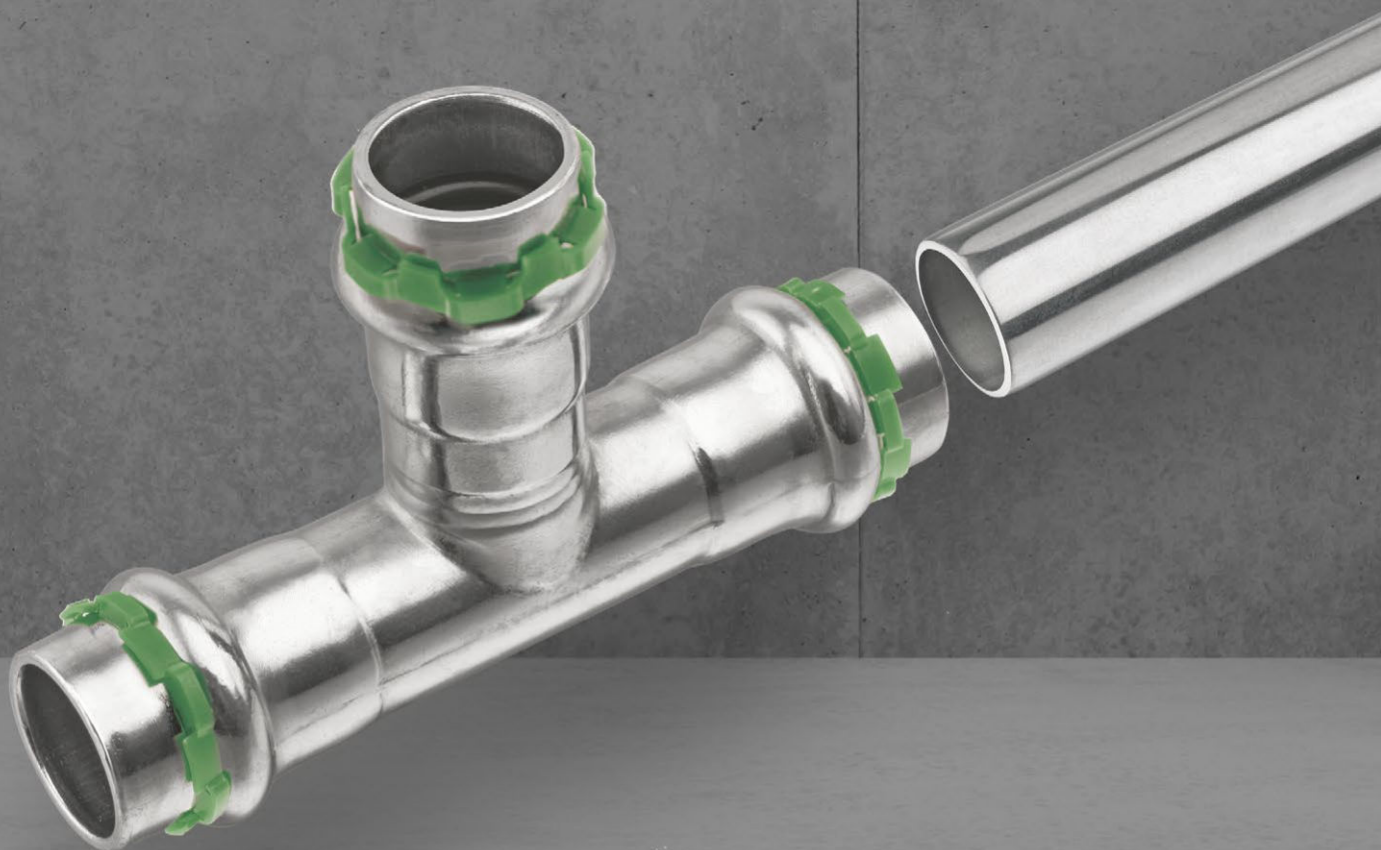

KAN-therm

Inox



**NEMES ANYAG,
GIGANTIKUS LEHETŐSÉGEK**

Install the **future**

Tartalomjegyzék

KAN-therm Inox rendszer V - termékválaszték

Csövek	21
Idomok	22
Kiegészítők	29
Szerszámok	31

O-gyűrű tömítés	Működési paraméterek	Alkalmazási terület
 <p>EPDM (fekete)</p>	<ul style="list-style-type: none"> ■ Üzemi hőmérséklet -20 °C – +110 °C ■ Maximális hőmérséklet +130 °C (rövid ideig) ■ Maximális üzemi nyomás 16 bar 	<ul style="list-style-type: none"> ■ Fűtőrendszerek ■ Gőz (max. 0,5 bar)* ■ Ivóvízrendszerek* ■ Kezeltvízrendszerek* ■ Esővízgyűjtés ■ Hűtőrendszerek 35%-ig terjedő glikoltartalommal ■ Sűrített levegős rendszerek**, 1. – 5. osztály az ISO 8573 szabványnak megfelelően, és inert gázok
 <p>FPM (zöld)</p>	<ul style="list-style-type: none"> ■ Üzemi hőmérséklet -20 °C – +180 °C ■ Maximális hőmérséklet +230 °C (rövid ideig) ■ Maximális üzemi nyomás 16 bar 	<ul style="list-style-type: none"> ■ Napelemes rendszerek ■ Víz-glikol keverék 50%-ig ■ Dízel üzemanyagok ■ Olajszállítás ■ Vákuum (min 0,8 bar) ■ Sűrített levegős rendszerek**, 1. – 6. osztály az ISO 8573 szabványnak megfelelően, és inert gázok ■ Nem alkalmas tiszta, forró vízhez (60 °C felett)

* Csak inox és réz

** Csak inox és réz, 1. – 3. osztály acél esetén

KAN-therm Inox rendszer V - termékválaszték

Csövek

Rozsdamentes acél cső, 1.4404 (AISI 316L) - szálaban

CSOPORT: H

Méret [mm]	*	Kód			Egys.
12x1,0	**	1629194065	6	1014	m
15x1,0	**	1629194001	6	762	m
18x1,0	**	1629194002	6	366	m
22x1,2	**	1629194003	6	366	m
28x1,2	**	1629194004	6	222	m
35x1,5	**	1629194005	6	222	m
42x1,5	**	1629194006	6	114	m
54x1,5	**	1629194007	6	114	m



Rozsdamentes acél cső, 1.4521 (AISI 444) - szálaban

CSOPORT: H

Méret [mm]	*	Kód			Egys.
15x1,0	**	1629194021	6	762	m
18x1,0	**	1629194023	6	396	m
22x1,2	**	1629194025	6	366	m
28x1,2	**	1629194027	6	222	m
35x1,5	**	1629194029	6	222	m
42x1,5	**	1629194031	6	114	m
54x1,5	**	1629194033	6	114	m



 tekerics
  szál
  köteg
  csomag
  papír doboz
  raklap
  új
  hamarosan elérhető

* megrendelésre – átfutási idő max. 5 hét | ** egyéni egyeztetés alapján igényelhető | *** készlet erejéig

Idomok



Külső menetes csatlakozó

CSOPORT: G1

Méret [mm]	*	Kód			Egys.
15 R $\frac{1}{2}$ "	**	1662045000	5	150	db.
15 R $\frac{3}{4}$ "	**	1662045001	5	80	db.
18 R $\frac{1}{2}$ "	**	1662045002	5	160	db.
18 R $\frac{3}{4}$ "	**	1662045003	5	100	db.
22 R $\frac{1}{2}$ "	**	1662045005	5	70	db.
22 R $\frac{3}{4}$ "	**	1662045006	5	100	db.
22 R1"	**	1662045004	5	60	db.
28 R $\frac{3}{4}$ "	**	1662045008	5	50	db.
28 R1"	**	1662045007	5	60	db.
35 R1 $\frac{1}{4}$ "	**	1662045010	5	40	db.
35 R1 $\frac{1}{2}$ "	**	1662045013	10	20	db.
35 R1"	**	1662045009	5	40	db.
42 R1 $\frac{1}{4}$ "	**	1662045014	4	12	db.
42 R1 $\frac{1}{2}$ "	**	1662045011	1	24	db.
54 R1 $\frac{1}{2}$ "	**	1662045015	4	16	db.
54 R2"	**	1662045012	1	12	db.



Külső menetes hollander toldattal

CSOPORT: G1

Méret [mm]	*	Kód			Egys.
15 R $\frac{1}{2}$ "	**	1662272000	5	50	db.
15 R $\frac{3}{4}$ "	**	1662272001	5	60	db.
18 R $\frac{1}{2}$ "	**	1662272002	5	60	db.
18 R $\frac{3}{4}$ "	**	1662272003	5	60	db.
22 R $\frac{1}{2}$ "	**	1662272004	5	40	db.
22 R $\frac{3}{4}$ "	**	1662272005	5	40	db.
22 R1"	**	1662272006	5	30	db.
28 R1"	**	1662272007	5	30	db.
35 R1 $\frac{1}{4}$ "	**	1662272008	5	15	db.
42 R1 $\frac{1}{2}$ "	**	1662272009	1	12	db.
54 R2"	**	1662272010	1	4	db.

tekercs
 szál
 köteg
 csomag
 papír doboz
 raklap
 új
 hamarosan elérhető

* megrendelésre – átfutási idő max. 5 hét | ** egyéni egyeztetés alapján igényelhető | *** készlet erejéig

Belső menetes csatlakozó

CSOPORT: G1

Méret [mm]	*	Kód			Egys.
15 Rp½"	**	1662044000	5	130	db.
15 Rp¾"	**	1662044001	5	90	db.
18 Rp½"	**	1662044002	5	120	db.
18 Rp¾"	**	1662044003	5	80	db.
22 Rp½"	**	1662044005	5	100	db.
22 Rp¾"	**	1662044006	5	100	db.
22 Rp1"	**	1662044004	5	60	db.
28 Rp½"	**	1662044013	10	40	db.
28 Rp¾"	**	1662044008	5	40	db.
28 Rp1"	**	1662044007	5	60	db.
35 Rp1¼"	**	1662044009	5	30	db.
35 Rp1"	**	1662044012	5	20	db.
42 Rp1¼"	**	1662044014	4	12	db.
42 Rp1½"	**	1662044010	1	24	db.
54 Rp1½"	**	1662044015	4	12	db.
54 Rp2"	**	1662044011	1	12	db.



Belső menetes hollandier toldattal

CSOPORT: G1

Méret [mm]	*	Kód			Egys.
15 Rp½"	**	1662119000	5	60	db.
15 Rp¾"	**	1662119001	5	40	db.
18 Rp½"	**	1662119002	5	40	db.
18 Rp¾"	**	1662119003	5	40	db.
22 Rp¾"	**	1662119004	5	40	db.
22 Rp1"	**	1662119005	5	30	db.
28 Rp1"	**	1662119006	5	25	db.
35 Rp1¼"	**	1662119007	5	20	db.
42 Rp1½"	**	1662119008	1	8	db.
54 Rp2"	**	1662119009	1	4	db.



Belső menetes félhollandi tömitéssel

CSOPORT: G1

Méret [mm]	*	Kód			Egys.
15 G¾"	**	1662106000	5	120	db.
18 G¾"	**	1662106001	5	100	db.
22 G1"	**	1662106002	5	60	db.
28 G1¼"	**	1662106003	5	40	db.
35 G1½"	**	1662106004	5	30	db.
42 G1¾"	**	1662106005	1	12	db.
54 G2⅝"	**	1662106006	1	8	db.



 tekercs  szál  köteg  csomag  papírdoboz  raklap  új  hamarosan elérhető

* megrendelésre – átfutási idő max. 5 hét | ** egyéni egyeztetés alapján igényelhető | *** készlet erejéig



Karmantyú

CSOPORT: G1

Méret [mm]	*	Kód			Egys.
15	**	1662245000	10	140	db.
18	**	1662245001	10	140	db.
22	**	1662245002	10	80	db.
28	**	1662245003	5	60	db.
35	**	1662245004	5	40	db.
42	**	1662245005	1	20	db.
54	**	1662245006	1	15	db.



Áttoló karmantyú

CSOPORT: G1

Méret [mm]	*	Kód			Egys.
15	**	1662080000	10	140	db.
18	**	1662080001	10	100	db.
22	**	1662080002	10	60	db.
28	**	1662080003	5	40	db.
35	**	1662080004	5	20	db.
42	**	1662080005	5	15	db.
54	**	1662080006	1	8	db.



Könyökidom, 90°

CSOPORT: G1

Méret [mm]	*	Kód			Egys.
15	**	1662302000	10	150	db.
18	**	1662302001	10	90	db.
22	**	1662302002	10	60	db.
28	**	1662302003	5	30	db.
35	**	1662302004	5	20	db.
42	**	1662302005	1	8	db.
54	**	1662302006	1	8	db.



KB könyökidom, 90°

CSOPORT: G1

Méret [mm]	*	Kód			Egys.
15	**	1662326000	10	120	db.
18	**	1662326001	10	60	db.
22	**	1662326002	10	60	db.
28	**	1662326003	5	30	db.
35	**	1662326004	5	10	db.
42	**	1662326005	1	8	db.
54	**	1662326006	1	6	db.

tekercs
 szál
 köteg
 csomag
 papír doboz
 raklap
 új
 hamarosan elérhető

* megrendelésre – átfutási idő max. 5 hét | ** egyéni egyeztetés alapján igényelhető | *** készlet erejéig

Könyökidom, 45°

CSOPORT: G1

Méret [mm]	*	Kód			Egys.
15	**	1662303000	10	150	db.
18	**	1662303001	10	120	db.
22	**	1662303002	10	70	db.
28	**	1662303003	5	40	db.
35	**	1662303004	5	25	db.
42	**	1662303005	1	16	db.
54	**	1662303006	1	8	db.



KB könyökidom, 45°

CSOPORT: G1

Méret [mm]	*	Kód			Egys.
15	**	1662325000	10	150	db.
18	**	1662325001	10	120	db.
22	**	1662325002	10	60	db.
28	**	1662325003	5	40	db.
35	**	1662325004	5	25	db.
42	**	1662325005	1	16	db.
54	**	1662325006	1	8	db.



T-idom

CSOPORT: G1

Méret [mm]	*	Kód			Egys.
15	**	1662257000	10	80	db.
18	**	1662257001	10	40	db.
22	**	1662257002	10	40	db.
28	**	1662257003	5	25	db.
35	**	1662257004	1	15	db.
42	**	1662257005	1	8	db.
54	**	1662257006	1	6	db.



Szűkített T-idom

CSOPORT: G1

Méret [mm]	*	Kód			Egys.
18 / 15 / 18	**	1662260000	10	60	db.
22 / 15 / 22	**	1662260001	10	50	db.
22 / 18 / 22	**	1662260002	10	50	db.
28 / 15 / 28	**	1662260003	5	30	db.
28 / 18 / 28	**	1662260004	5	30	db.
28 / 22 / 28	**	1662260005	5	30	db.
35 / 15 / 35	**	1662260006	1	20	db.
35 / 18 / 35	**	1662260007	1	20	db.
35 / 22 / 35	**	1662260008	1	20	db.
35 / 28 / 35	**	1662260009	1	20	db.
42 / 22 / 42	**	1662260010	1	12	db.
42 / 28 / 42	**	1662260011	1	12	db.
42 / 35 / 42	**	1662260012	1	12	db.
54 / 22 / 54	**	1662260013	1	8	db.
54 / 28 / 54	**	1662260014	1	8	db.
54 / 35 / 54	**	1662260015	1	8	db.
54 / 42 / 54	**	1662260016	1	8	db.



 tekercs  szál  köteg  csomag  papír doboz  raklap  új  hamarosan elérhető

* megrendelésre – átfutási idő max. 5 hét | ** egyéni egyeztetés alapján igényelhető | *** készlet erejéig



Szűkített T-idom, préselhető profil (M-V-M)

CSOPORT: G1

Méret [mm]	*	Kód			Egys.
76,1 / 42 / 76,1	**	1662260017	2	-	db.
76,1 / 54 / 76,1	**	1662260018	2	-	db.
88,9 / 42 / 88,9	**	1662260019	2	-	db.
88,9 / 54 / 88,9	**	1662260020	2	-	db.
108 / 42 / 108	**	1662260021	2	-	db.
108 / 54 / 108	**	1662260022	2	-	db.

Megjegyzés:

A „Szűkített T-idom, préselési profil (M-V-M)” megjelölésű tételt különböző présprofilú présprofákkal kell préselni. A 42 mm-es és 54 mm-es átmérőket „V” profilú présprofákkal, a 76,1 mm-es, 88,9 mm-es és 108 mm-es átmérőket pedig „M” profilú présprofákkal kell préselni.



KB szűkítő idom

CSOPORT: G1

Méret [mm]	*	Kód			Egys.
18 / 15	**	1662221000	10	200	db.
22 / 15	**	1662221001	10	140	db.
22 / 18	**	1662221002	10	120	db.
28 / 15	**	1662221003	5	70	db.
28 / 18	**	1662221004	10	100	db.
28 / 22	**	1662221005	10	80	db.
35 / 22	**	1662221006	5	50	db.
35 / 28	**	1662221007	1	35	db.
42 / 22	**	1662221008	5	25	db.
42 / 28	**	1662221009	1	24	db.
42 / 35	**	1662221010	5	20	db.
54 / 22	**	1662221011	1	16	db.
54 / 28	**	1662221012	1	16	db.
54 / 35	**	1662221013	1	16	db.
54 / 42	**	1662221014	1	16	db.
35 / 18	**	1662221015	5	50	db.
76,1 / 42	**	1662221016	4	-	db.
76,1 / 54	**	1662221017	4	-	db.
88,9 / 54	**	1662221018	4	-	db.



Külső menetes könyökidom, 90°

CSOPORT: G1

Méret [mm]	*	Kód			Egys.
15 R1/2"	**	1662070000	5	80	db.
18 R1/2"	**	1662070001	5	80	db.
22 R3/4"	**	1662070002	5	60	db.
28 R1"	**	1662070003	5	30	db.
35 R1 1/4"	**	1662070004	5	20	db.
42 R1 1/2"	**	1662070005	1	16	db.
54 R2"	**	1662070006	1	8	db.

Külső menetes T-idom

CSOPORT: G1

Méret [mm]	*	Kód			Egys.
15 R $\frac{1}{2}$ "	**	1662259000	5	70	db.
18 R $\frac{1}{2}$ "	**	1662259001	5	50	db.
18 R $\frac{3}{4}$ "	**	1662259002	5	40	db.
22 R $\frac{1}{2}$ "	**	1662259003	5	40	db.
22 R $\frac{3}{4}$ "	**	1662259004	5	30	db.
28 R $\frac{3}{4}$ "	**	1662259005	5	30	db.
35 R $\frac{3}{4}$ "	**	1662259006	5	20	db.
42 R $\frac{3}{4}$ "	**	1662259007	1	14	db.
28 R1"	**	1662259008	5	30	db.
35 R1"	**	1662259009	5	20	db.
42 R1"	**	1662259010	1	12	db.
54 R1"	**	1662259011	1	8	db.



Belső menetes könyökidom, 90°

CSOPORT: G1

Méret [mm]	*	Kód			Egys.
15 Rp $\frac{1}{2}$ "	**	1662069000	5	80	db.
18 Rp $\frac{1}{2}$ "	**	1662069001	5	90	db.
22 Rp $\frac{3}{4}$ "	**	1662069002	5	50	db.
28 Rp1"	**	1662069003	5	30	db.
35 Rp1 $\frac{1}{4}$ "	**	1662069004	5	10	db.
42 Rp1 $\frac{1}{2}$ "	**	1662069005	1	10	db.
54 Rp2"	**	1662069006	1	8	db.



Belső menetes könyökidom, 90°, betolható véggel

CSOPORT: G

Méret [mm]	*	Kód			Egys.
15 Rp $\frac{1}{2}$ "	**	1609068013	10	40	db.



Belső menetes T-idom

CSOPORT: G1

Méret [mm]	*	Kód			Egys.
15 Rp $\frac{1}{2}$ "	**	1662258000	5	70	db.
18 Rp $\frac{1}{2}$ "	**	1662258001	5	50	db.
18 Rp $\frac{3}{4}$ "	**	1662258012	5	50	db.
22 Rp $\frac{1}{2}$ "	**	1662258002	5	40	db.
22 Rp $\frac{3}{4}$ "	**	1662258003	5	40	db.
28 Rp $\frac{1}{2}$ "	**	1662258004	5	30	db.
28 Rp $\frac{3}{4}$ "	**	1662258005	5	30	db.
28 Rp1"	**	1662258013	5	30	db.
35 Rp $\frac{1}{2}$ "	**	1662258006	5	20	db.
35 Rp $\frac{3}{4}$ "	**	1662258014	5	20	db.
35 Rp1"	**	1662258009	5	20	db.
42 Rp $\frac{1}{2}$ "	**	1662258007	1	14	db.
42 Rp1"	**	1662258010	1	12	db.
54 Rp $\frac{1}{2}$ "	**	1662258008	1	8	db.
54 Rp1"	**	1662258011	1	8	db.





Belső menetes, talpas falikorong

CSOPORT: G1

Méret [mm]	*	Kód			Egys.
15 Rp $\frac{1}{2}$ " L = 41 mm	**	1662286000	5	90	db.
18 Rp $\frac{1}{2}$ " L = 44 mm	**	1662286001	5	60	db.
22 Rp $\frac{3}{4}$ " L = 52 mm	**	1662286002	5	50	db.



Belső menetes, talpas falikorong

CSOPORT: G1

Méret [mm]	*	Kód			Egys.
15 Rp $\frac{1}{2}$ " L = 63 mm	**	1662286003	20	40	db.
18 Rp $\frac{1}{2}$ " L = 63 mm	**	1662286004	20	40	db.



Végdugó



CSOPORT: G1

Méret [mm]	*	Kód			Egys.
15	**	1662250000	10	160	db.
18	**	1662250001	10	300	db.
22	**	1662250002	10	150	db.
28	**	1662250003	5	130	db.
35	**	1662250004	1	60	db.
42	**	1662250005	1	40	db.
54	**	1662250006	1	24	db.

Kiegészítők

Kerülő idom

CSOPORT: G

Méret [mm]	*	Kód			Egys.
15	**	1609178001	10	50	db.
18	**	1609178002	10	50	db.
22	**	1609178003	10	20	db.
28	**	1609178003	10	20	db.



15°-os csőív

CSOPORT: G

Méret [mm]	*	Kód			Egys.
28	**	1609011002	10	40	db.
35	**	1609011003	5	15	db.
42	**	1609011004	2	20	db.
54	**	1609011005	2	6	db.



30°-os csőív



CSOPORT: G

Méret [mm]	*	Kód			Egys.
28	**	1609011009	10	40	db.
35	**	1609011008	4	12	db.
42	**	1609011010	2	20	db.
54	**	1609011011	2	8	db.



60°-os csőív

CSOPORT: G

Méret [mm]	*	Kód			Egys.
28	**	1609011014	5	30	db.
35	**	1609011015	4	12	db.
42	**	1609011016	5	20	db.
54	**	1609011017	2	6	db.



90°-os csőív

CSOPORT: G

Méret [mm]	*	Kód			Egys.
15	**	1609011018	10	70	db.
18	**	1609011019	10	50	db.
22	**	1609011025	10	30	db.
28	**	1609011026	5	20	db.
35	**	1609011027	4	8	db.
42	**	1609011028	2	4	db.
54	**	1609011029	2	10	db.



 tekercs
  szál
  köteg
  csomag
  papírdoboz
  raklap
  új
  hamarosan elérhető

* megrendelésre – átfutási idő max. 5 hét | ** egyéni egyeztetés alapján igényelhető | *** készlet erejéig



Karima hegeszthető toldat, PN16

CSOPORT: G1

Méret [mm]	*	Kód			Egys.
15	**	1662091000	1	15	db.
18	**	1662091001	1	15	db.
22	**	1662091002	1	12	db.
28	**	1662091003	1	10	db.
35	**	1662091004	1	6	db.
42	**	1662091005	1	4	db.
54	**	1662091006	1	2	db.



EPDM lapos tömítés hollanderes idomhoz (fekete)

CSOPORT: I

Méret [mm]	*	Kód			Egys.
15-18	**	1562237000	20	500	db.
22	**	1562237001	20	500	db.
28	**	1562237002	20	400	db.
35	**	1562237003	20	400	db.
42	**	1562237004	20	300	db.
54	**	1562237005	20	300	db.



O-gyűrű, LBP EPDM

CSOPORT: P1

Méret [mm]	*	Kód			Egys.
12	**	2261182000	20	1000	db.
15	**	2261182001	20	600	db.
18	**	2261182002	20	500	db.
22	**	2261182003	20	500	db.
28	**	2261182004	20	400	db.
35	**	2261182005	20	400	db.
42	**	1562182000	20	300	db.
54	**	1562182001	20	300	db.



O-gyűrű, LBP FPM

CSOPORT: P1

Méret [mm]	*	Kód			Egys.
15	**	2260182000	20	600	db.
18	**	2260182001	20	500	db.
22	**	2260182002	20	500	db.
28	**	2260182003	20	400	db.
35	**	2260182004	20	400	db.
42	**	1562182002	20	300	db.
54	**	1562182003	20	300	db.

Szerszámok

Görgős csóvágó REMS RAS St

CSOPORT: K

Méret [mm]	*	Kód		Egys.
12-54 mm	**	1948267025	1	db.
35-108 mm	**	1948267027	1	db.



Csóvágógép REMS Cento

CSOPORT: K

Méret [mm]	*	Kód		Egys.
22-108 mm	**	1948183001	1	db.

Megjegyzés:

A készlet tartalmaz egy csóvágó eszközt és egy vágókereket.



Sorjázó fém csőhöz REMS REG

CSOPORT: K

Méret [mm]	*	Kód			Egys.
12-54 mm	**	1948267015	1	6	db.



REMS Power-Press ACC elektromos préselő szerszám

CSOPORT: K

Méret [mm]	*	Kód		Egys.
12-54	**	1936267219	1	db.

Megjegyzés:

A préselő szerszám dobozzal kapható.
A készlet nem tartalmazza a pófákat.



REMS Power-Press SE Basic Pack elektromos préselő szerszám

CSOPORT: K

Méret [mm]	*	Kód		Egys.
12-54	**	1936267160	1	db.

Megjegyzés:

A présgép kofferben kerül értékesítésre.
A készlet nem tartalmazza a pófákat.



REMS Akku-Press akkumulátoros préselő szerszám

CSOPORT: K

Méret [mm]	*	Kód		Egys.
12-54	**	1936267152	1	db.

Megjegyzés:

A préselő szerszám akkumulátorral, töltővel és dobozzal kapható.
A készlet nem tartalmazza a pófákat.



 tekercs  szál  köteg  csomag  papír doboz  raklap  új  hamarosan elérhető

* megrendelésre – átfutási idő max. 5 hét | ** egyéni egyeztetés alapján igényelhető | *** készlet erejéig



REMS "V" profilos préselő pófák

CSOPORT: K

Méret [mm]	*	Kód			Egys.
12	**	1948267173	1	48	db.
15	**	1948267174	1	500	db.
18	**	1948267175	1	500	db.
22	**	1948267176	1	500	db.
28	**	1948267177	1	500	db.
35	**	1948267178	1	48	db.
42	**	1948267179	1	200	db.
54	**	1948267180	1	48	db.

Megjegyzés:

A szorítópófák Power-Press SE, Akku-Press és Power-Press ACC préselőgépekkel kompatibilisek.



Novopress szerszámkészlet - ACO103 BT akkumulátoros préselő szerszám + „V” profilos pófák

CSOPORT: K

Méret [mm]	*	Kód		Egys.
15-28	**	1948055009	1	db.

Mindegyik készlet tartalma:

- Akkumulátoros préselő szerszám - 1 db.,
- 1948267168 - V15 pófák préselő szerszámhoz - 1 db.,
- 1948267169 - V18 pófák préselő szerszámhoz - 1 db.,
- 1948267170 - V22 pófák préselő szerszámhoz - 1 db.,
- 1948267171 - V28 pófák préselő szerszámhoz - 1 db.,
- 1938267047 - Akkumulátortöltő - 1 db.,
- 1938267002 - 2 Ah akkumulátor - 2 db.,
- Doboz - 1 db.



Novopress PB1 "V" profilos préselő pófák

CSOPORT: K

Méret [mm]	*	Kód			Egys.
12	**	1948267167	1	500	db.
35	**	1948267172	1	320	db.

Megjegyzés:

A szorítópófák ACO103 préselőgépekkel kompatibilisek.



Novopress ACO203XL BT préselő szerszám

CSOPORT: K

Méret [mm]	*	Kód		Egys.
15-54	**	1948267181	1	db.

Mindegyik készlet tartalma:

- akkumulátoros préselő szerszám - 1 db.,
- milwaukee 18 V / 5,0 Ah Li -ion akkumulátor - 2 db.,
- akkumulátortöltő - 1 db.,
- kenőanyag - 1 db.,
- műanyag doboz.



Novopress EFP203 elektromos préselő szerszám

CSOPORT: K

Méret [mm]	*	Kód		Egys.
12-54	**	1948267210	1	db.

Megjegyzés:

A préselő szerszám műanyag dobozzal kapható.

tekercs szál köteg csomag papír doboz raklap új hamarosan elérhető

* megrendelés – átfutási idő max. 5 hét | ** egyéni egyeztetés alapján igényelhető | *** készlet erejéig

Novopress PB2 "V" profilos préselő pófák

CSOPORT: K

Méret [mm]	*	Kód			Egys.
12	**	1948267211	1	500	db.
15	**	1948267212	1	500	db.
18	**	1948267213	1	500	db.
22	**	1948267214	1	500	db.
28	**	1948267215	1	500	db.
35	**	1948267216	1	500	db.
42	**	1948267217	1	100	db.
54	**	1948267218	1	100	db.





Megjegyzés:

A pófák EFP203 és ACO203XL hajtóegységekkel használhatók.

Novopress "V" profilos rápattintható karmantyú

CSOPORT: K

Méret [mm]	*	Kód			Egys.
42	**	1905267015	1	100	db.
54	**	1905267016	1	100	db.

Megjegyzés:

A 42 - 54 mm átmérőjű prés pófákat a ZB203 adapterrel használja.
A pófák EFP203 és ACO203XL hajtóegységekkel használhatók.



Novopress ZB203 adapter

CSOPORT: K

Méret [mm]	*	Kód		Egys.
42-54	**	1948267000	1	db.

Megjegyzés:

Adapter EFP203 és ACO203XL hajtóegységekhez.



JEGYZET

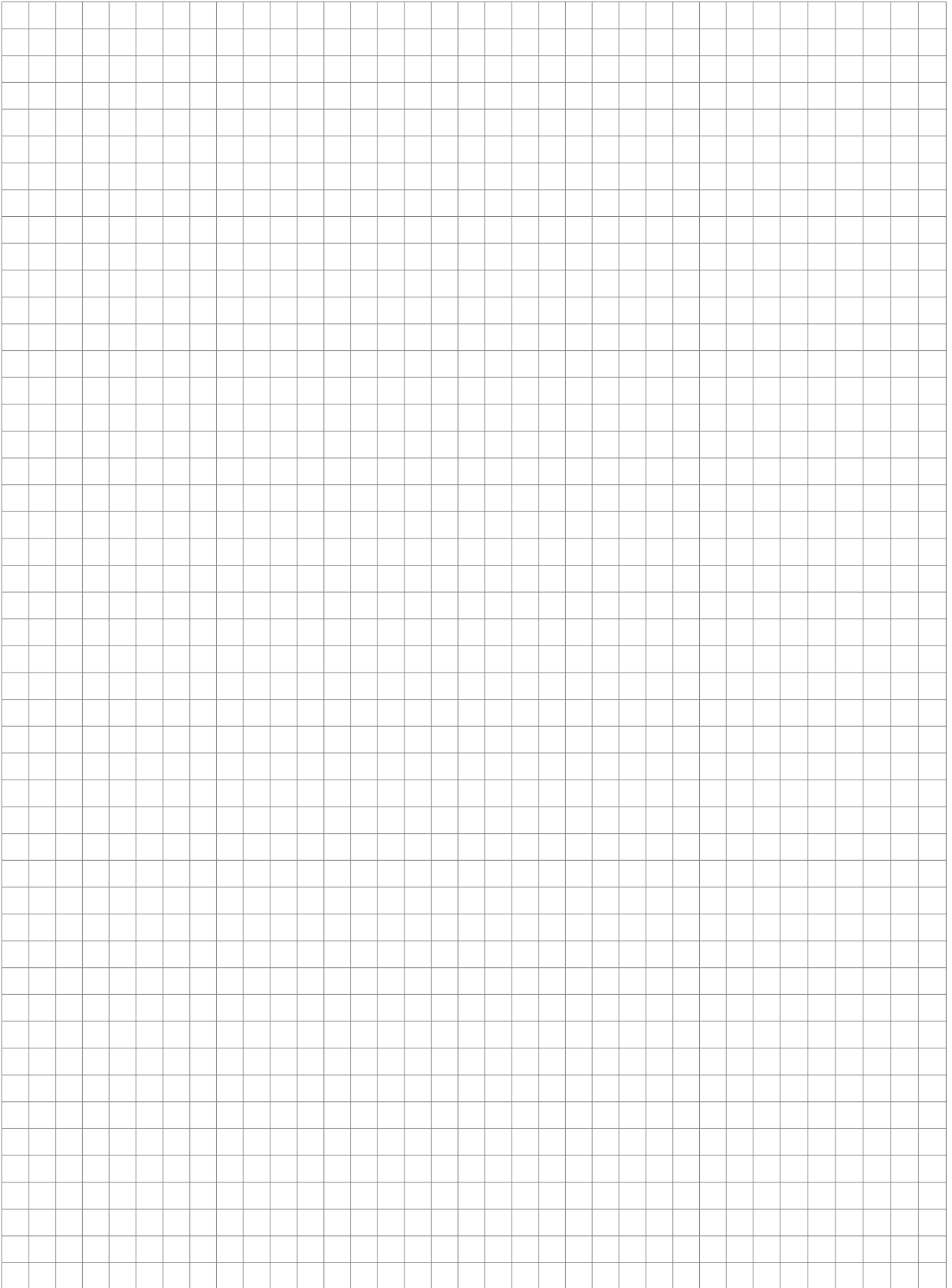

 tekerccs  szál  köteg  csomag  papír doboz  raklap **N** új  hamarosan elérhető

* megrendelésre – átfutási idő max. 5 hét | ** egyéni egyeztetés alapján igényelhető | *** készlet erejéig



KAN-therm
MULTISYSTEM

> 35 | év tapasztalat
a szerelési piacon



KAN-therm

Copper

KLASSZIKUS MEGOLDÁSOK
MODERN MEGKÖZELÍTÉSE

Install the **future**



Tartalomjegyzék

KAN-therm Copper rendszer V - termékválaszték

Idomok	37
Kiegészítők	45

KAN-therm Copper rendszer V Gas - termékválaszték

Idomok	46
Kiegészítők	50
Szerszámok	51

O-gyűrű tömítés	Működési paraméterek	Alkalmazási terület
 <p>EPDM (fekete)</p>	<ul style="list-style-type: none"> ■ Üzemi hőmérséklet -20 °C – +110 °C ■ Maximális hőmérséklet +150 °C (rövid ideig) ■ Maximális üzemi nyomás 16 bar 	<ul style="list-style-type: none"> ■ Fűtőrendszerek ■ Gőz (max. 0,5 bar)* ■ Ivóvízrendszerek* ■ Kezeltvízrendszerek* ■ Esővízgyűjtés ■ Hűtőrendszerek 35%-ig terjedő glikoltartalommal ■ Sűrített levegős rendszerek**, 1. – 5. osztály az ISO 8573 szabványnak megfelelően, és inert gázok
 <p>FPM (zöld)</p>	<ul style="list-style-type: none"> ■ Üzemi hőmérséklet -20 °C – +180 °C ■ Maximális hőmérséklet +230 °C (rövid ideig) ■ Maximális üzemi nyomás 16 bar 	<ul style="list-style-type: none"> ■ Napelemes rendszerek ■ Víz-glikol keverék 50%-ig ■ Dízel üzemanyagok ■ Olajszállítás ■ Vákuum (min 0,8 bar) ■ Sűrített levegős rendszerek, 1. – 6. osztály az ISO 8573 szabványnak megfelelően, és inert gázok ■ Nem alkalmas tiszta, forró vízhez (60 °C felett)
 <p>HNBR (sárga)</p>	<ul style="list-style-type: none"> ■ Üzemi hőmérséklet -20 °C až +70 °C, ■ Maximális üzemi nyomás 5 bar (épületeken belüli és kívüli telepítésekhez, földszinten vezetve). 	<ul style="list-style-type: none"> ■ Földgáz*** ■ LPG*** ■ Vákuum (min 0,8 bar) ■ Sűrített levegős rendszerek, 1. – 6. osztály az ISO 8573 szabványnak megfelelően, és inert gázok

* Csak inox és c

** Csak inox és réz, 1. – 3. osztály acél esetén



*** Belül és kívül, csak talajszint fölött

KAN-therm Copper rendszer V - termékválaszték

Idomok

Külső menetes csatlakozó



CSOPORT: P1

Méret [mm]	*	Kód			Egys.
12 R $\frac{1}{2}$ "	**	2261045001	5	150	db.
15 R $\frac{1}{2}$ "	**	2261045002	5	150	db.
15 R $\frac{3}{4}$ "	**	2261045003	5	100	db.
18 R $\frac{1}{2}$ "	**	2261045004	5	100	db.
18 R $\frac{3}{4}$ "	**	2261045005	5	75	db.
22 R $\frac{1}{2}$ "	**	2261045006	5	75	db.
22 R $\frac{3}{4}$ "	**	2261045007	5	75	db.
22 R1"	**	2261045008	5	60	db.
28 R $\frac{3}{4}$ "	**	2261045009	5	50	db.
28 R1"	**	2261045010	5	50	db.
28 R1 $\frac{1}{4}$ "	**	2261045011	5	50	db.
35 R1"	**	2261045012	5	30	db.
35 R1 $\frac{1}{4}$ "	**	2261045013	1	20	db.
42 R1 $\frac{1}{4}$ "	**	2261045015	1	30	db.
42 R1 $\frac{1}{2}$ "	**	2261045016	1	20	db.
54 R1 $\frac{1}{2}$ "	**	2261045017	1	10	db.
54 R2"	**	2261045018	1	10	db.



Belső menetes csatlakozó

CSOPORT: P1

Méret [mm]	*	Kód			Egys.
15 Rp $\frac{3}{8}$ "	**	2261044002	5	100	db.
15 Rp $\frac{1}{2}$ "	**	2261044003	5	100	db.
15 Rp $\frac{3}{4}$ "	**	2261044004	5	100	db.
18 Rp $\frac{1}{2}$ "	**	2261044005	5	100	db.
18 Rp $\frac{3}{4}$ "	**	2261044006	5	80	db.
22 Rp $\frac{1}{2}$ "	**	2261044007	5	75	db.
22 Rp $\frac{3}{4}$ "	**	2261044008	5	75	db.
22 Rp1"	**	2261044009	5	60	db.
28 Rp $\frac{3}{4}$ "	**	2261044010	5	60	db.
28 Rp1"	**	2261044011	5	50	db.
28 Rp1 $\frac{1}{4}$ "	**	2261044012	5	40	db.
35 Rp1"	**	2261044013	5	30	db.
35 Rp1 $\frac{1}{4}$ "	**	2261044014	5	30	db.
42 Rp1 $\frac{1}{4}$ "	**	2261044015	1	15	db.
42 Rp1 $\frac{1}{2}$ "	**	2261044016	1	15	db.
54 Rp2"	**	2261044017	1	20	db.





Külső menetes csatlakozó forraszvég

CSOPORT: P

Méret [mm]	*	Kód			Egys.
12 R1/2"	**	2261329000	5	100	db.
15 R1/2"	**	2261329001	5	100	db.
18 R1/2"	**	2261329002	5	100	db.
18 R3/4"	**	2261329003	5	80	db.
22 R1/2"	**	2261329004	5	100	db.
22 R3/4"	**	2261329005	5	75	db.
28 R1"	**	2261329006	5	60	db.
35 R1 1/4"	**	2261329007	5	30	db.
42 R1 1/2"	**	2261329008	1	20	db.



Belső menetes forraszvég

CSOPORT: P

Méret [mm]	*	Kód			Egys.
12 Rp1/2"	**	2261328000	5	80	db.
15 Rp1/2"	**	2261328001	5	80	db.
18 Rp1/2"	**	2261328002	5	80	db.
18 Rp3/4"	**	2261328003	5	60	db.
22 Rp1/2"	**	2261328004	5	80	db.
22 Rp3/4"	**	2261328005	5	75	db.
28 Rp3/4"	**	2261328006	5	50	db.
28 Rp1"	**	2261328007	5	50	db.
35 Rp1"	**	2261328008	1	40	db.



Belső menetes hollandis csatlakozó

CSOPORT: P1

Méret [mm]	*	Kód			Egys.
15 Rp3/4"	**	2261119002	5	50	db.
18 Rp1/2"	**	2261119003	5	50	db.
18 Rp3/4"	**	2261119004	5	40	db.
22 Rp3/4"	**	2261119005	5	40	db.
22 Rp1"	**	2261119006	5	30	db.
28 Rp1"	**	2261119007	5	30	db.
35 Rp1 1/4"	**	2261119008	5	20	db.
42 Rp1 1/2"	**	2261119009	1	10	db.
54 Rp2"	**	2261119010	1	8	db.



Hollandi csatlakozó

CSOPORT: P1



Méret [mm]	*	Kód			Egys.
18	**	2261065002	5	50	db.
28	**	2261065004	5	25	db.

tekercs
 szál
 köteg
 csomag
 papír doboz
 raklap
 új
 hamarosan elérhető

* megrendelésre – átfutási idő max. 5 hét | ** egyéni egyeztetés alapján igényelhető | *** készlet erejéig

Külső menetes, hollandis csatlakozó

CSOPORT: P1

Méret [mm]	*	Kód			Egys.
12 R $\frac{3}{8}$ "	**	2261272000	5	75	db.
12 R $\frac{1}{2}$ "	**	2261272001	5	60	db.
15 R $\frac{1}{2}$ "	**	2261272002	5	75	db.
18 R $\frac{1}{2}$ "	**	2261272004	5	50	db.
18 R $\frac{3}{4}$ "	**	2261272005	5	40	db.
22 R $\frac{1}{2}$ "	**	2261272006	5	50	db.
22 R $\frac{3}{4}$ "	**	2261272007	5	40	db.
22 R1"	**	2261272008	5	30	db.
28 R1"	**	2261272009	5	30	db.
35 R1 $\frac{1}{4}$ "	**	2261272010	1	10	db.
42 R1 $\frac{1}{2}$ "	**	2261272011	1	15	db.
54 R2"	**	2261272012	1	8	db.



Hollander lapostömítéssel, préselhető kötés – belső menet



CSOPORT: P1

Méret [mm]	*	Kód			Egys.
22 G $\frac{3}{4}$ "	**	2261271000	5	100	db.



Toldó



CSOPORT: P1

Méret [mm]	*	Kód			Egys.
12	**	2261245000	10	200	db.
15	**	2261245001	10	250	db.
18	**	2261245002	10	250	db.
22	**	2261245003	10	150	db.
28	**	2261245004	10	100	db.
35	**	2261245005	5	30	db.
42	**	2261245006	1	20	db.
54	**	2261245007	1	25	db.



Szűkített toldó

CSOPORT: P1

Méret [mm]	*	Kód			Egys.
15 / 12	**	2261330000	10	200	db.
18 / 15	**	2261330001	10	150	db.
22 / 15	**	2261330002	10	150	db.
22 / 18	**	2261330003	10	150	db.
28 / 22	**	2261330004	10	150	db.
35 / 28	**	2261330005	5	75	db.
42 / 35	**	2261330006	1	25	db.
54 / 42	**	2261330007	1	25	db.





Áttoló karmantyú

CSOPORT: P1

Méret [mm]	*	Kód			Egys.
12	**	2261245008	5	150	db.
15	**	2261245009	5	100	db.
18	**	2261245010	5	75	db.
22	**	2261245011	5	75	db.
28	**	2261245012	5	50	db.
35	**	2261245013	5	25	db.
42	**	2261245014	1	15	db.



Könyökidom, 90°

CSOPORT: P1

Méret [mm]	*	Kód			Egys.
12	**	2261302000	10	200	db.
15	**	2261302001	10	150	db.
18	**	2261302002	10	150	db.
22	**	2261302003	10	120	db.
28	**	2261302004	5	80	db.
35	**	2261302005	5	25	db.
42	**	2261302006	1	25	db.
54	**	2261302007	1	15	db.



KM könyökidom, 90°

CSOPORT: P1

Méret [mm]	*	Kód			Egys.
12	**	2261326000	10	200	db.
15	**	2261326001	10	150	db.
18	**	2261326002	10	150	db.
22	**	2261326003	10	100	db.
28	**	2261326004	5	60	db.
35	**	2261326005	5	25	db.
42	**	2261326006	1	25	db.
54	**	2261326007	1	15	db.



Könyökidom, 45°

CSOPORT: P1



Méret [mm]	*	Kód			Egys.
12	**	2261303000	10	200	db.
15	**	2261303001	10	200	db.
18	**	2261303002	10	150	db.
22	**	2261303003	10	150	db.
28	**	2261303004	5	100	db.
35	**	2261303005	5	50	db.
42	**	2261303006	1	25	db.
54	**	2261303007	1	20	db.

tekercs
 szál
 köteg
 csomag
 papír doboz
 raklap
 új
 hamarosan elérhető

* megrendelésre – átfutási idő max. 5 hét | ** egyéni egyeztetés alapján igényelhető | *** készlet erejéig

KM könyökidom, 45°



CSOPORT: P1

Méret [mm]	*	Kód			Egys.
12	**	2261325000	10	200	db.
15	**	2261325001	10	200	db.
18	**	2261325002	10	150	db.
22	**	2261325003	10	150	db.
28	**	2261325004	5	100	db.
35	**	2261325005	5	50	db.
42	**	2261325006	1	25	db.
54	**	2261325007	1	20	db.



Szűkítő idom



CSOPORT: P1

Méret [mm]	*	Kód			Egys.
22 / 15	**	2261221000	10	150	db.
15 / 12	**	2261221001	10	200	db.
18 / 12	**	2261221002	10	200	db.
18 / 15	**	2261221003	10	200	db.
22 / 18	**	2261221004	10	150	db.
28 / 15	**	2261221005	10	100	db.
28 / 18	**	2261221006	10	100	db.
28 / 22	**	2261221007	10	100	db.
35 / 22	**	2261221008	5	75	db.
35 / 28	**	2261221009	5	75	db.
42 / 22	**	2261221010	1	50	db.
42 / 28	**	2261221011	1	50	db.
42 / 35	**	2261221012	1	50	db.
54 / 35	**	2261221013	1	20	db.
54 / 42	**	2261221014	1	25	db.



T-idom

CSOPORT: P1

Méret [mm]	*	Kód			Egys.
12	**	2261257000	10	150	db.
15	**	2261257001	10	100	db.
18	**	2261257002	10	100	db.
22	**	2261257003	5	60	db.
28	**	2261257004	5	50	db.
35	**	2261257005	1	25	db.
42	**	2261257006	1	20	db.
54	**	2261257007	1	10	db.





Szűkített T-idom

CSOPORT: P1

Méret [mm]	*	Kód			Egys.
12 / 15 / 12	**	2261260000	10	200	db.
15 / 18 / 15	**	2261260004	10	100	db.
18 / 12 / 18	**	2261260006	10	100	db.
18 / 15 / 15	**	2261260007	10	100	db.
18 / 15 / 18	**	2261260008	10	100	db.
18 / 18 / 15	**	2261260009	10	100	db.
18 / 22 / 18	**	2261260010	5	100	db.
22 / 12 / 22	**	2261260011	5	75	db.
22 / 15 / 15	**	2261260012	5	80	db.
22 / 15 / 18	**	2261260013	5	80	db.
22 / 15 / 22	**	2261260014	5	80	db.
22 / 18 / 15	**	2261260015	5	80	db.
22 / 18 / 18	**	2261260016	5	80	db.
22 / 18 / 22	**	2261260017	5	80	db.
22 / 22 / 15	**	2261260018	5	80	db.
22 / 22 / 18	**	2261260019	5	80	db.
22 / 28 / 22	**	2261260020	5	50	db.
28 / 15 / 28	**	2261260022	5	50	db.
28 / 18 / 22	**	2261260023	5	50	db.
28 / 18 / 28	**	2261260024	5	50	db.
28 / 22 / 22	**	2261260025	5	50	db.
28 / 22 / 28	**	2261260026	5	50	db.
28 / 28 / 15	**	2261260027	5	50	db.
28 / 28 / 18	**	2261260028	5	50	db.
28 / 28 / 22	**	2261260029	5	50	db.
35 / 15 / 35	**	2261260030	1	25	db.
35 / 18 / 35	**	2261260031	1	25	db.
35 / 22 / 35	**	2261260033	1	25	db.
35 / 28 / 28	**	2261260034	1	25	db.
35 / 28 / 35	**	2261260035	1	25	db.
42 / 22 / 42	**	2261260036	1	25	db.
42 / 28 / 42	**	2261260037	1	25	db.
42 / 35 / 42	**	2261260039	1	20	db.
54 / 22 / 54	**	2261260040	1	10	db.
54 / 28 / 54	**	2261260041	1	10	db.
54 / 35 / 54	**	2261260042	1	10	db.
54 / 42 / 54	**	2261260044	1	10	db.



Külső menetes könyökidom, 90°

CSOPORT: P1

Méret [mm]	*	Kód			Egys.
15 R $\frac{1}{2}$ "	**	2261070002	5	60	db.
18 R $\frac{1}{2}$ "	**	2261070003	5	60	db.
18 R $\frac{3}{4}$ "	**	2261070004	5	60	db.
22 R $\frac{3}{4}$ "	**	2261070005	5	50	db.
28 R1"	**	2261070006	5	30	db.

tekerics szál köteg csomag papír doboz raklap új hamarosan elérhető

* megrendelésre – átfutási idő max. 5 hét | ** egyéni egyeztetés alapján igényelhető | *** készlet erejéig

Belső menetes könyökidom, 90°

CSOPORT: P1

Méret [mm]	*	Kód			Egys.
12 Rp½"	**	2261069000	5	80	db.
15 Rp½"	**	2261069002	5	60	db.
18 Rp½"	**	2261069004	5	60	db.
18 Rp¾"	**	2261069005	5	60	db.
22 Rp½"	**	2261069006	5	50	db.
22 Rp¾"	**	2261069007	5	45	db.
28 Rp1"	**	2261069008	5	25	db.



Belső menetes T-idom



CSOPORT: P1

Méret [mm]	*	Kód			Egys.
12 Rp½"	**	2261258000	5	50	db.
15 Rp½"	**	2261258001	5	50	db.
18 Rp½"	**	2261258002	5	50	db.
22 Rp½"	**	2261258003	5	50	db.
22 Rp¾"	**	2261258004	5	50	db.
28 Rp½"	**	2261258005	5	40	db.
28 Rp¾"	**	2261258006	5	40	db.
35 Rp½"	**	2261258007	5	20	db.
42 Rp½"	**	2261258008	1	12	db.
54 Rp½"	**	2261258009	1	8	db.



Belső menetes, talpas falikorong

CSOPORT: P1

Méret [mm]	*	Kód			Egys.
15 Rp½" L = 35 mm	**	2261286001	5	60	db.
18 Rp½" L = 39 mm	**	2261286002	5	50	db.
22 Rp¾" L = 49 mm	**	2261286003	5	30	db.



Falikorong szerelőlap belső menetes talpas falikorong

CSOPORT: P1

Méret [mm]	*	Kód			Egys.
15 Rp½" L = 150 mm, D=25 mm	**	2261286004	1	20	db.



Falikorong egység, belső menetes préselhető csatlakozással

CSOPORT: P1

Méret [mm]	*	Kód			Egys.
15 Rp½" L = 150 mm	**	2261286005	1	20	db.



 tekercs  szál  köteg  csomag  papír doboz  raklap  új  hamarosan elérhető

* megrendelésre – átfutási idő max. 5 hét | ** egyéni egyeztetés alapján igényelhető | *** készlet erejéig



Záródugó

CSOPORT: P1

Méret [mm]	*	Kód			Egys.
12	**	2261250008	10	500	db.
15	**	2261250009	10	500	db.
18	**	2261250010	10	200	db.
22	**	2261250011	10	200	db.
28	**	2261250012	10	200	db.
35	**	2261250013	5	100	db.
42	**	2261250014	1	50	db.
54	**	2261250015	1	50	db.



Végdugó idomhoz, préselési profil nélkül (másik idomba történő préseléshez)

CSOPORT: P1

Méret [mm]	*	Kód			Egys.
28	**	2261250004	5	200	db.



Kerülő idom 180°

CSOPORT: P1

Méret [mm]	*	Kód			Egys.
15	**	2261022000	10	100	db.
18	**	2261022001	10	100	db.
22	**	2261022002	5	50	db.



KB kerülő idom



CSOPORT: P1

Méret [mm]	*	Kód			Egys.
12	**	2261022003	10	150	db.
15	**	2261022004	10	100	db.
18	**	2261022005	10	100	db.
22	**	2261022006	5	50	db.

Kiegészítők

O-gyűrű, LBP EPDM



CSOPORT: P1

Méret [mm]	*	Kód			Egys.
12	**	2261182000	20	1000	db.
15	**	2261182001	20	600	db.
18	**	2261182002	20	500	db.
22	**	2261182003	20	500	db.
28	**	2261182004	20	400	db.
35	**	2261182005	20	400	db.
42	**	2261182006	5	1250	db.
54	**	2261182007	20	1000	db.



O-gyűrű, LBP FPM

CSOPORT: P1

Méret [mm]	*	Kód			Egys.
15	**	2260182000	20	600	db.
18	**	2260182001	20	500	db.
22	**	2260182002	20	500	db.
28	**	2260182003	20	400	db.
35	**	2260182004	20	400	db.
42	**	2260182005	5	1250	db.
54	**	2260182006	5	1250	db.



 tekercs
  szál
  köteg
  csomag
  papírdoboz
  raklap
  új
  hamarosan elérhető

* megrendelésre – átfutási idő max. 5 hét | ** egyéni egyeztetés alapján igényelhető | *** készlet erejéig

KAN-therm Copper rendszer V Gas - termékválaszték

Idomok



Külső menetes csatlakozó

CSOPORT: P1

Méret [mm]	*	Kód			Egys.
15 R $\frac{1}{2}$ "	**	2254045000	5	150	db.
15 R $\frac{3}{4}$ "	**	2254045001	5	100	db.
18 R $\frac{1}{2}$ "	**	2254045002	5	100	db.
18 R $\frac{3}{4}$ "	**	2254045003	5	75	db.
22 R $\frac{1}{2}$ "	**	2254045004	5	75	db.
22 R $\frac{3}{4}$ "	**	2254045005	5	75	db.
22 R1"	**	2254045006	5	50	db.
28 R $\frac{3}{4}$ "	**	2254045007	5	50	db.
28 R1"	**	2254045008	5	50	db.
28 R1 $\frac{1}{4}$ "	**	2254045009	5	50	db.
35 R1"	**	2254045010	1	30	db.
35 R1 $\frac{1}{4}$ "	**	2254045011	1	20	db.
42 R1 $\frac{1}{4}$ "	**	2254045013	1	30	db.
42 R1 $\frac{1}{2}$ "	**	2254045014	1	20	db.
54 R2"	**	2254045016	1	10	db.



Belső menetes csatlakozó

CSOPORT: P1

Méret [mm]	*	Kód			Egys.
15 Rp $\frac{1}{2}$ "	**	2254044000	5	100	db.
15 Rp $\frac{3}{4}$ "	**	2254044001	5	80	db.
18 Rp $\frac{1}{2}$ "	**	2254044002	5	100	db.
18 Rp $\frac{3}{4}$ "	**	2254044003	5	80	db.
22 Rp $\frac{1}{2}$ "	**	2254044004	5	75	db.
22 Rp $\frac{3}{4}$ "	**	2254044005	5	75	db.
22 Rp1"	**	2254044006	5	60	db.
28 Rp1"	**	2254044007	5	50	db.
35 Rp1 $\frac{1}{4}$ "	**	2254044008	5	15	db.
42 Rp1 $\frac{1}{2}$ "	**	2254044009	1	15	db.
54 Rp2"	**	2254044010	1	12	db.



Toldó

CSOPORT: P1



Méret [mm]	*	Kód			Egys.
15	**	2254245000	10	250	db.
18	**	2254245001	10	250	db.
22	**	2254245002	10	150	db.
28	**	2254245003	10	150	db.
35	**	2254245004	5	30	db.
42	**	2254245005	1	20	db.
54	**	2254245006	1	25	db.

tekercs szál köteg csomag papír doboz raklap **N** új hamarosan elérhető

* megrendelésre – átfutási idő max. 5 hét | ** egyéni egyeztetés alapján igényelhető | *** készlet erejéig

Áttoló karmantyú



CSOPORT: P1

Méret [mm]	*	Kód			Egys.
15	**	2254080000	5	100	db.
18	**	2254080001	5	75	db.
22	**	2254080002	5	75	db.
28	**	2254080003	5	50	db.
35	**	2254080004	5	25	db.



Könyökidom, 90°



CSOPORT: P1

Méret [mm]	*	Kód			Egys.
15	**	2254302000	10	150	db.
18	**	2254302001	10	150	db.
22	**	2254302002	10	100	db.
28	**	2254302003	5	80	db.
35	**	2254302004	5	25	db.
42	**	2254302005	1	25	db.
54	**	2254302006	1	15	db.



KM könyökidom, 90°



CSOPORT: P1

Méret [mm]	*	Kód			Egys.
15	**	2254326000	10	150	db.
18	**	2254326001	10	150	db.
22	**	2254326002	10	150	db.
28	**	2254326003	5	60	db.
35	**	2254326004	5	25	db.
42	**	2254326005	1	25	db.
54	**	2254326006	1	15	db.



Könyökidom, 45°

CSOPORT: P1

Méret [mm]	*	Kód			Egys.
15	**	2254303000	10	200	db.
18	**	2254303001	10	150	db.
22	**	2254303002	10	150	db.
28	**	2254303003	5	100	db.
35	**	2254303004	5	50	db.
42	**	2254303005	1	25	db.
54	**	2254303006	1	20	db.





KM könyökidom, 45°

CSOPORT: P1

Méret [mm]	*	Kód			Egys.
15	**	2254325000	10	200	db.
18	**	2254325001	10	150	db.
22	**	2254325002	10	150	db.
28	**	2254325003	5	100	db.
35	**	2254325004	5	50	db.
42	**	2254325005	1	25	db.
54	**	2254325006	1	20	db.



T-idom

CSOPORT: P1

Méret [mm]	*	Kód			Egys.
15	**	2254257000	10	100	db.
18	**	2254257001	10	100	db.
22	**	2254257002	5	60	db.
28	**	2254257003	5	50	db.
35	**	2254257004	1	25	db.
42	**	2254257005	1	25	db.
54	**	2254257006	1	10	db.



Szűkített T-idom

CSOPORT: P1



Méret [mm]	*	Kód			Egys.
18 / 15 / 18	**	2254260000	10	100	db.
22 / 15 / 22	**	2254260002	5	80	db.
22 / 18 / 22	**	2254260003	5	80	db.
22 / 22 / 15	**	2254260004	5	80	db.
28 / 15 / 28	**	2254260005	5	60	db.
28 / 22 / 28	**	2254260006	5	50	db.
35 / 22 / 35	**	2254260007	1	25	db.
35 / 28 / 35	**	2254260008	1	25	db.
42 / 28 / 42	**	2254260009	1	25	db.
42 / 35 / 42	**	2254260010	1	20	db.
54 / 42 / 54	**	2254260011	1	10	db.

tekerccs
 szál
 kötég
 csomag
 papír doboz
 raklap
 új
 hamarosan elérhető

* megrendelésre – átfutási idő max. 5 hét | ** egyéni egyeztetés alapján igényelhető | *** készlet erejéig

Szűkítő idom



CSOPORT: P1

Méret [mm]	*	Kód			Egys.
18 / 15	**	2254221000	10	200	db.
22 / 15	**	2254221001	10	150	db.
22 / 18	**	2254221002	10	150	db.
28 / 15	**	2254221003	10	100	db.
28 / 18	**	2254221004	10	100	db.
28 / 22	**	2254221005	10	100	db.
35 / 22	**	2254221006	5	75	db.
35 / 28	**	2254221007	5	75	db.
42 / 22	**	2254221008	5	50	db.
42 / 28	**	2254221009	1	50	db.
42 / 35	**	2254221010	1	50	db.
54 / 35	**	2254221011	1	20	db.
54 / 42	**	2254221012	1	25	db.



Záródugó

CSOPORT: P1

Méret [mm]	*	Kód			Egys.
15	**	2254250000	10	200	db.
18	**	2254250001	10	200	db.
22	**	2254250002	10	200	db.
28	**	2254250003	10	200	db.
35	**	2254250004	5	100	db.



 tekercs
  szál
  köteg
  csomag
  papír doboz
  raklap
  új
  hamarosan elérhető

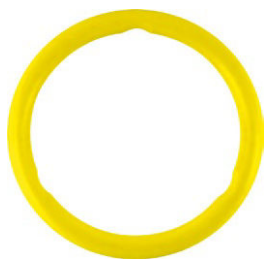

* megrendelésre – átfutási idő max. 5 hét | ** egyéni egyeztetés alapján igényelhető | *** készlet erejéig

Kiegészítők



O-gyűrű, LBP HNBR

CSOPORT: P1

Méret [mm]	*	Kód			Egys.
15	**	2254182000	5	1250	db.
18	**	2254182001	5	1250	db.
22	**	2254182002	5	1250	db.
28	**	2254182003	5	1250	db.
35	**	2254182004	5	1250	db.
42	**	2254182005	5	1250	db.
54	**	2254182006	5	1250	db.

 tekerics  szál  kötég  csomag  papír doboz  raklap **N** új  hamarosan elérhető

* megrendelésre – átfutási idő max. 5 hét | ** egyéni egyeztetés alapján igényelhető | *** készlet erejéig

Szerszámok

ROTHENBERGER rézcső vágó (görgős vágó)

CSOPORT: K

Méret [mm]	*	Kód		Egys.
12-54	**	1905267014	1	db.



Sorjázó csőhöz Rothenberger

CSOPORT: K

Méret [mm]	*	Kód		Egys.
12-54	**	1905267012	1	6 db.



REMS Power-Press ACC elektromos préselő szerző

CSOPORT: K

Méret [mm]	*	Kód		Egys.
	**	1936267219	1	db.

Megjegyzés:

A préselő szerző dobozzal kapható.
A készlet nem tartalmazza a pófákat.



REMS Power-Press SE Basic Pack elektromos préselő szerző

CSOPORT: K

Méret [mm]	*	Kód		Egys.
	**	1936267160	1	db.

Megjegyzés:

A présőgép kofferben kerül értékesítésre.
A készlet nem tartalmazza a pófákat.



REMS Akku-Press akkumulátoros préselő szerző

CSOPORT: K

Méret [mm]	*	Kód		Egys.
	**	1936267152	1	db.



Megjegyzés:

A préselő szerző akkumulátorral, töltővel és dobozzal kapható.
A készlet nem tartalmazza a pófákat.



REMS "V" profilos préselő pófák

CSOPORT: K

Méret [mm]	*	Kód			Egys.
12	**	1948267173	1	48	db.
15	**	1948267174	1	500	db.
18	**	1948267175	1	500	db.
22	**	1948267176	1	500	db.
28	**	1948267177	1	500	db.
35	**	1948267178	1	48	db.

Megjegyzés:

A szorítópófák Power-Press SE, Akku-Press és Power-Press ACC préselőgépekkel kompatibilisek.



 tekercs  szál  köteg  csomag  papír doboz  raklap  új  hamarosan elérhető

* megrendelés – átfutási idő max. 5 hét | ** egyéni egyeztetés alapján igényelhető | *** készlet erejéig



Novopress szerszámkészlet - ACO103 BT akkumulátoros préselő szerszám + „V” profilos pofák

CSOPORT: K

Méret [mm]	*	Kód		Egys.
15-28	**	1948055009	1	db.

Mindegyik készlet tartalma:

- Akkumulátoros préselő szerszám - 1 db.,
- 1948267168 - V15 pofák préselő szerszámhoz - 1 db.,
- 1948267169 - V18 pofák préselő szerszámhoz - 1 db.,
- 1948267170 - V22 pofák préselő szerszámhoz - 1 db.,
- 1948267171 - V28 pofák préselő szerszámhoz - 1 db.,
- 1938267047 - Akkumulátortöltő - 1 db.,
- 1938267002 - 2 Ah akkumulátor - 2 db.,
- Doboz - 1 db.



Novopress PB1 "V" profilos préselő pofák

CSOPORT: K

Méret [mm]	*	Kód			Egys.
12	**	1948267167	1	1	db.
35	**	1948267172	1	1	db.

Megjegyzés:

A szorítópofák ACO103 préselőgépekkel kompatibilisek.



Novopress ACO203XL BT préselő szerszám

CSOPORT: K

Méret [mm]	*	Kód		Egys.
12-54	**	1948267181	10	db.

Mindegyik készlet tartalma:

- akkumulátoros préselő szerszám - 1 db.,
- milwaukee 18 V / 5,0 Ah Li-ion akkumulátor - 2 db.,
- akkumulátortöltő - 1 db.,
- kenőanyag - 1 db.,
- műanyag doboz.



Novopress EFP203 elektromos préselő szerszám

CSOPORT: K



Méret [mm]	*	Kód		Egys.
12-54	**	1948267210	25	db.

Megjegyzés:

A préselő szerszám műanyag dobozzal kapható.

Novopress PB2 "V" profilos préselő pófák

CSOPORT: K

Méret [mm]	*	Kód			Egys.
12	**	1948267211	1	500	db.
15	**	1948267212	1	500	db.
18	**	1948267213	1	500	db.
22	**	1948267214	1	500	db.
28	**	1948267215	1	500	db.
35	**	1948267216	1	500	db.



Megjegyzés:

A pófák EFP203 és ACO203XL hajtóegységekkel használhatók.

Novopress "V" profilos rápattintható karmantyú

CSOPORT: K

Méret [mm]	*	Kód			Egys.
42	**	1905267015	1	100	db.
54	**	1905267016	1	100	db.



Megjegyzés:

A 42 - 54 mm átmérőjű prés pófákat a ZB203 adapterrel használja.

A pófák EFP203 és ACO203XL hajtóegységekkel használhatók.

Novopress ZB203 adapter

CSOPORT: K

Méret [mm]	*	Kód		Egys.
42-54	**	1948267000	1	db.

Megjegyzés:

Adapter EFP203 és ACO203XL hajtóegységekhez.



INDEX

Kód	o.	Kód	o.	Kód	o.	Kód	o.	Kód	o.
1509011000	12	1562045010	6	1562182002	30	1562250006	12	1562272005	6
1509011002	12	1562045011	6	1562182003	14	1562257000	9	1562272006	6
1509011003	12	1562045012	6	1562182003	30	1562257001	9	1562302000	8
1509011004	12	1562045013	6	1562221000	10	1562257002	9	1562302001	8
1509011005	12	1562069000	11	1562221001	10	1562257003	9	1562302002	8
1509011007	12	1562069001	11	1562221002	10	1562257004	9	1562302003	8
1509011008	12	1562069002	11	1562221003	10	1562257005	9	1562302004	8
1509011009	12	1562069003	11	1562221004	10	1562257006	9	1562302005	8
1509022005	11	1562070000	10	1562221005	10	1562258000	11	1562302006	8
1509022006	11	1562070001	10	1562221006	10	1562258001	11	1562302007	8
1509022007	11	1562070002	10	1562221007	10	1562258002	11	1562303000	8
1509022008	11	1562070003	10	1562221008	10	1562258003	11	1562303001	8
1509178000	11	1562070004	10	1562221009	10	1562258004	11	1562303002	8
1530207027	5	1562070005	10	1562221010	10	1562258005	11	1562303003	8
1530207028	5	1562070006	10	1562221011	10	1562258006	11	1562303004	8
1530207029	5	1562070007	10	1562221012	10	1562258007	11	1562303005	8
1530207030	5	1562070008	11	1562221013	10	1562258008	11	1562303006	8
1530207031	5	1562070009	11	1562221014	10	1562258009	11	1562325000	9
1530207032	5	1562070010	11	1562221015	10	1562258010	11	1562325001	9
1530207033	5	1562070011	11	1562221016	10	1562258011	11	1562325002	9
1530207034	5	1562076001	7	1562221017	10	1562260000	9	1562325003	9
1562040000	13	1562076002	7	1562221018	10	1562260001	9	1562325004	9
1562040001	13	1562076003	7	1562221019	10	1562260002	9	1562325005	9
1562040002	13	1562076004	7	1562221020	10	1562260003	9	1562325006	9
1562040003	13	1562076005	7	1562237000	13	1562260004	9	1562326000	8
1562040004	13	1562076006	7	1562237000	30	1562260005	9	1562326001	8
1562040005	13	1562080000	8	1562237001	13	1562260006	9	1562326002	8
1562040006	13	1562080001	8	1562237001	30	1562260007	9	1562326003	8
1562044000	7	1562080002	8	1562237002	13	1562260008	9	1562326004	8
1562044001	7	1562080003	8	1562237002	30	1562260009	9	1562326005	8
1562044002	7	1562080004	8	1562237003	13	1562260010	9	1562326006	8
1562044003	7	1562080005	8	1562237003	30	1562260011	9	1562326007	8
1562044004	7	1562080006	8	1562237004	13	1562260012	9	1609011002	29
1562044005	7	1562106000	6	1562237004	30	1562260013	9	1609011003	29
1562044006	7	1562106001	6	1562237005	13	1562260014	9	1609011004	29
1562044007	7	1562106002	6	1562237005	30	1562260015	9	1609011005	29
1562044008	7	1562106003	6	1562245000	7	1562260016	9	1609011008	29
1562044009	7	1562106004	6	1562245001	7	1562260017	9	1609011009	29
1562044010	7	1562119000	7	1562245002	7	1562260018	9	1609011010	29
1562044011	7	1562119001	7	1562245003	7	1562260019	10	1609011011	29
1562045000	6	1562119002	7	1562245004	7	1562260020	10	1609011014	29
1562045001	6	1562119003	7	1562245005	7	1562260021	10	1609011015	29
1562045002	6	1562119004	7	1562245006	7	1562260022	10	1609011016	29
1562045003	6	1562119005	7	1562245007	7	1562260023	10	1609011017	29
1562045004	6	1562119006	7	1562250000	12	1562260024	10	1609011018	29
1562045005	6	1562182000	13	1562250001	12	1562272000	6	1609011019	29
1562045006	6	1562182000	30	1562250002	12	1562272001	6	1609011025	29
1562045007	6	1562182001	13	1562250003	12	1562272002	6	1609011026	29
1562045008	6	1562182001	30	1562250004	12	1562272003	6	1609011027	29
1562045009	6	1562182002	14	1562250005	12	1562272004	6	1609011028	29

INDEX

Kód	o.	Kód	o.	Kód	o.	Kód	o.	Kód	o.
1609011029	29	1662045013	22	1662221002	26	1662258012	27	1662286001	28
1609068013	27	1662045014	22	1662221003	26	1662258013	27	1662286002	28
1609178001	29	1662045015	22	1662221004	26	1662258014	27	1662286003	28
1609178002	29	1662069000	27	1662221005	26	1662259000	27	1662286004	28
1609178003	29	1662069001	27	1662221006	26	1662259001	27	1662302000	24
1609178003	29	1662069002	27	1662221007	26	1662259002	27	1662302001	24
1629194001	21	1662069003	27	1662221008	26	1662259003	27	1662302002	24
1629194002	21	1662069004	27	1662221009	26	1662259004	27	1662302003	24
1629194003	21	1662069005	27	1662221010	26	1662259005	27	1662302004	24
1629194004	21	1662069006	27	1662221011	26	1662259006	27	1662302005	24
1629194005	21	1662070000	26	1662221012	26	1662259007	27	1662302006	24
1629194006	21	1662070001	26	1662221013	26	1662259008	27	1662303000	25
1629194007	21	1662070002	26	1662221014	26	1662259009	27	1662303001	25
1629194021	21	1662070003	26	1662221015	26	1662259010	27	1662303002	25
1629194023	21	1662070004	26	1662221016	26	1662259011	27	1662303003	25
1629194025	21	1662070005	26	1662221017	26	1662260000	25	1662303004	25
1629194027	21	1662070006	26	1662221018	26	1662260001	25	1662303005	25
1629194029	21	1662080000	24	1662245000	24	1662260002	25	1662303006	25
1629194031	21	1662080001	24	1662245001	24	1662260003	25	1662325000	25
1629194033	21	1662080002	24	1662245002	24	1662260004	25	1662325001	25
1629194065	21	1662080003	24	1662245003	24	1662260005	25	1662325002	25
1662044000	23	1662080004	24	1662245004	24	1662260006	25	1662325003	25
1662044001	23	1662080005	24	1662245005	24	1662260007	25	1662325004	25
1662044002	23	1662080006	24	1662245006	24	1662260008	25	1662325005	25
1662044003	23	1662091000	30	1662250000	28	1662260009	25	1662325006	25
1662044004	23	1662091001	30	1662250001	28	1662260010	25	1662326000	24
1662044005	23	1662091002	30	1662250002	28	1662260011	25	1662326001	24
1662044006	23	1662091003	30	1662250003	28	1662260012	25	1662326002	24
1662044007	23	1662091004	30	1662250004	28	1662260013	25	1662326003	24
1662044008	23	1662091005	30	1662250005	28	1662260014	25	1662326004	24
1662044009	23	1662091006	30	1662250006	28	1662260015	25	1662326005	24
1662044010	23	1662106000	23	1662257000	25	1662260016	25	1662326006	24
1662044011	23	1662106001	23	1662257001	25	1662260017	26	1905267012	51
1662044012	23	1662106002	23	1662257002	25	1662260018	26	1905267014	51
1662044013	23	1662106003	23	1662257003	25	1662260019	26	1905267015	17
1662044014	23	1662106004	23	1662257004	25	1662260020	26	1905267015	33
1662044015	23	1662106005	23	1662257005	25	1662260021	26	1905267015	53
1662045000	22	1662106006	23	1662257006	25	1662260022	26	1905267016	17
1662045001	22	1662119000	23	1662258000	27	1662272000	22	1905267016	33
1662045002	22	1662119001	23	1662258001	27	1662272001	22	1905267016	53
1662045003	22	1662119002	23	1662258002	27	1662272002	22	1936267152	15
1662045004	22	1662119003	23	1662258003	27	1662272003	22	1936267152	31
1662045005	22	1662119004	23	1662258004	27	1662272004	22	1936267152	51
1662045006	22	1662119005	23	1662258005	27	1662272005	22	1936267160	15
1662045007	22	1662119006	23	1662258006	27	1662272006	22	1936267160	31
1662045008	22	1662119007	23	1662258007	27	1662272007	22	1936267160	51
1662045009	22	1662119008	23	1662258008	27	1662272008	22	1936267219	15
1662045010	22	1662119009	23	1662258009	27	1662272009	22	1936267219	31
1662045011	22	1662221000	26	1662258010	27	1662272010	22	1936267219	51
1662045012	22	1662221001	26	1662258011	27	1662286000	28	1948055009	16

INDEX

Kód	o.	Kód	o.	Kód	o.	Kód	o.	Kód	o.
1948055009	32	1948267212	17	2254182000	50	2254302000	47	2261022005	44
1948055009	52	1948267212	33	2254182001	50	2254302001	47	2261022006	44
1948183001	15	1948267212	53	2254182002	50	2254302002	47	2261044002	37
1948183001	31	1948267213	17	2254182003	50	2254302003	47	2261044003	37
1948267000	17	1948267213	33	2254182004	50	2254302004	47	2261044004	37
1948267000	33	1948267213	53	2254182005	50	2254302005	47	2261044005	37
1948267000	53	1948267214	17	2254182006	50	2254302006	47	2261044006	37
1948267015	15	1948267214	33	2254221000	49	2254303000	47	2261044007	37
1948267015	31	1948267214	53	2254221001	49	2254303001	47	2261044008	37
1948267025	15	1948267215	17	2254221002	49	2254303002	47	2261044009	37
1948267025	31	1948267215	33	2254221003	49	2254303003	47	2261044010	37
1948267027	15	1948267215	53	2254221004	49	2254303004	47	2261044011	37
1948267027	31	1948267216	17	2254221005	49	2254303005	47	2261044012	37
1948267167	16	1948267216	33	2254221006	49	2254303006	47	2261044013	37
1948267167	32	1948267216	53	2254221007	49	2254325000	48	2261044014	37
1948267167	52	1948267217	17	2254221008	49	2254325001	48	2261044015	37
1948267172	16	1948267217	33	2254221009	49	2254325002	48	2261044016	37
1948267172	32	1948267218	17	2254221010	49	2254325003	48	2261044017	37
1948267172	52	1948267218	33	2254221011	49	2254325004	48	2261045001	37
1948267173	16	2254044000	46	2254221012	49	2254325005	48	2261045002	37
1948267173	32	2254044001	46	2254245000	46	2254325006	48	2261045003	37
1948267173	51	2254044002	46	2254245001	46	2254326000	47	2261045004	37
1948267174	16	2254044003	46	2254245002	46	2254326001	47	2261045005	37
1948267174	32	2254044004	46	2254245003	46	2254326002	47	2261045006	37
1948267174	51	2254044005	46	2254245004	46	2254326003	47	2261045007	37
1948267175	16	2254044006	46	2254245005	46	2254326004	47	2261045008	37
1948267175	32	2254044007	46	2254245006	46	2254326005	47	2261045009	37
1948267175	51	2254044008	46	2254250000	49	2254326006	47	2261045010	37
1948267176	16	2254044009	46	2254250001	49	2260182000	14	2261045011	37
1948267176	32	2254044010	46	2254250002	49	2260182000	30	2261045012	37
1948267176	51	2254045000	46	2254250003	49	2260182000	45	2261045013	37
1948267177	16	2254045001	46	2254250004	49	2260182001	14	2261045015	37
1948267177	32	2254045002	46	2254257000	48	2260182001	30	2261045016	37
1948267177	51	2254045003	46	2254257001	48	2260182001	45	2261045017	37
1948267178	16	2254045004	46	2254257002	48	2260182002	14	2261045018	37
1948267178	32	2254045005	46	2254257003	48	2260182002	30	2261065002	38
1948267178	51	2254045006	46	2254257004	48	2260182002	45	2261065004	38
1948267179	16	2254045007	46	2254257005	48	2260182003	14	2261069000	43
1948267179	32	2254045008	46	2254257006	48	2260182003	30	2261069002	43
1948267180	16	2254045009	46	2254260000	48	2260182003	45	2261069004	43
1948267180	32	2254045010	46	2254260002	48	2260182004	14	2261069005	43
1948267181	16	2254045011	46	2254260003	48	2260182004	30	2261069006	43
1948267181	32	2254045013	46	2254260004	48	2260182004	45	2261069007	43
1948267181	52	2254045014	46	2254260005	48	2260182005	45	2261069008	43
1948267210	16	2254045016	46	2254260006	48	2260182006	45	2261070002	42
1948267210	32	2254080000	47	2254260007	48	2261022000	44	2261070003	42
1948267210	52	2254080001	47	2254260008	48	2261022001	44	2261070004	42
1948267211	17	2254080002	47	2254260009	48	2261022002	44	2261070005	42
1948267211	33	2254080003	47	2254260010	48	2261022003	44	2261070006	42
1948267211	53	2254080004	47	2254260011	48	2261022004	44	226119002	38

INDEX

Kód	o.	Kód	o.	Kód	o.	Kód	o.
2261119003	38	2261245007	39	2261260019	42	2261303002	40
2261119004	38	2261245008	40	2261260020	42	2261303003	40
2261119005	38	2261245009	40	2261260022	42	2261303004	40
2261119006	38	2261245010	40	2261260023	42	2261303005	40
2261119007	38	2261245011	40	2261260024	42	2261303006	40
2261119008	38	2261245012	40	2261260025	42	2261303007	40
2261119009	38	2261245013	40	2261260026	42	2261325000	41
2261119010	38	2261245014	40	2261260027	42	2261325001	41
2261182000	13	2261250004	44	2261260028	42	2261325002	41
2261182000	30	2261250008	44	2261260029	42	2261325003	41
2261182000	45	2261250009	44	2261260030	42	2261325004	41
2261182001	13	2261250010	44	2261260031	42	2261325005	41
2261182001	30	2261250011	44	2261260033	42	2261325006	41
2261182001	45	2261250012	44	2261260034	42	2261325007	41
2261182002	13	2261250013	44	2261260035	42	2261326000	40
2261182002	30	2261250014	44	2261260036	42	2261326001	40
2261182002	45	2261250015	44	2261260037	42	2261326002	40
2261182003	13	2261257000	41	2261260039	42	2261326003	40
2261182003	30	2261257001	41	2261260040	42	2261326004	40
2261182003	45	2261257002	41	2261260041	42	2261326005	40
2261182004	13	2261257003	41	2261260042	42	2261326006	40
2261182004	30	2261257004	41	2261260044	42	2261326007	40
2261182004	45	2261257005	41	2261271000	39	2261328000	38
2261182005	13	2261257006	41	2261272000	39	2261328001	38
2261182005	30	2261257007	41	2261272001	39	2261328002	38
2261182005	45	2261258000	43	2261272002	39	2261328003	38
2261182006	45	2261258001	43	2261272004	39	2261328004	38
2261182007	45	2261258002	43	2261272005	39	2261328005	38
2261221000	41	2261258003	43	2261272006	39	2261328006	38
2261221001	41	2261258004	43	2261272007	39	2261328007	38
2261221002	41	2261258005	43	2261272008	39	2261328008	38
2261221003	41	2261258006	43	2261272009	39	2261329000	38
2261221004	41	2261258007	43	2261272010	39	2261329001	38
2261221005	41	2261258008	43	2261272011	39	2261329002	38
2261221006	41	2261258009	43	2261272012	39	2261329003	38
2261221007	41	2261260000	42	2261286001	43	2261329004	38
2261221008	41	2261260004	42	2261286002	43	2261329005	38
2261221009	41	2261260006	42	2261286003	43	2261329006	38
2261221010	41	2261260007	42	2261286004	43	2261329007	38
2261221011	41	2261260008	42	2261286005	43	2261329008	38
2261221012	41	2261260009	42	2261302000	40	2261330000	39
2261221013	41	2261260010	42	2261302001	40	2261330001	39
2261221014	41	2261260011	42	2261302002	40	2261330002	39
2261245000	39	2261260012	42	2261302003	40	2261330003	39
2261245001	39	2261260013	42	2261302004	40	2261330004	39
2261245002	39	2261260014	42	2261302005	40	2261330005	39
2261245003	39	2261260015	42	2261302006	40	2261330006	39
2261245004	39	2261260016	42	2261302007	40	2261330007	39
2261245005	39	2261260017	42	2261303000	40		
2261245006	39	2261260018	42	2261303001	40		



KAN-therm HUNGARY Kft.

Mészárosok útja 4.

2051 Biatorbágy

tel.+36 23 77 0062

tel.+36 70 408 8563

e-mail: info.hungary@kan-therm.com

www.kan-therm.com

Teljes többcélú szerelési rendszer, amely korszerű, egymást kiegészítő műszaki megoldásokból áll a csővízelosztáshoz, a fűtési és hűtési berendezésekhez, valamint a technológiai és tűzoltási berendezésekhez.

ultra**LINE**

ultra**PRESS**

PP

Steel

Inox

Copper, Copper Gas

XPress Sprinkler

**Football
stadion-berendezések**

**Felületi fűtés és hűtés,
automatizálás**

Szekrények és elosztók

