

Safety for years to come



SYSTEM **KAN-therm**

Sprinkler Catalogue

Technical information
Product range

EN 2016



TECHNOLOGY OF SUCCESS



ISO 9001



About KAN

Innovative water and heating installations

KAN is a recognised in Europe Polish manufacturer of the KAN-therm system - the most modern system for indoor water, central heating, floor heating, extinguishing and technological installations.

We owe our current leading position to acting based on four strong pillars: uncompromised quality, innovative solutions, many years of experience and professionalism noticeable at all stages.

The continuous development of the KAN-therm System is a part of our philosophy - we make all effort to offer our users a product at the highest technical level, meeting all expectations related to it, providing comfort of use and perfect functioning of the installation and, thus, the feeling of complete safety. Bearing in mind health of the users, we provide highest quality products, produced and used without any conflict with the natural environment, friendly in relation to people and surrounding.

System KAN-therm features a perfect implementation of the vision of a universal system, backed by many years of experience and passion of KAN constructors as well as strict quality control of materials and the end products. Therefore, the KAN-therm system remains the unchallenged leader among the installation systems in Poland and is increasingly popular abroad. Products designated with the KAN-therm mark are exported to 23 countries of Europe, Asia and Africa.



KAN-therm SYSTEM - top quality product, awarded with the Gold Emblem of Quality International 2014 and 2013 as well as Teraz Polska (Poland Now) 2014.

In connection with the highest quality of products and application of modern solutions, the KAN company received an award in the prestigious Teraz Polska (Poland Now) contest as well as in the Quality International programme for years 2014 and 2013.

TECHNOLOGY OF SUCCESS



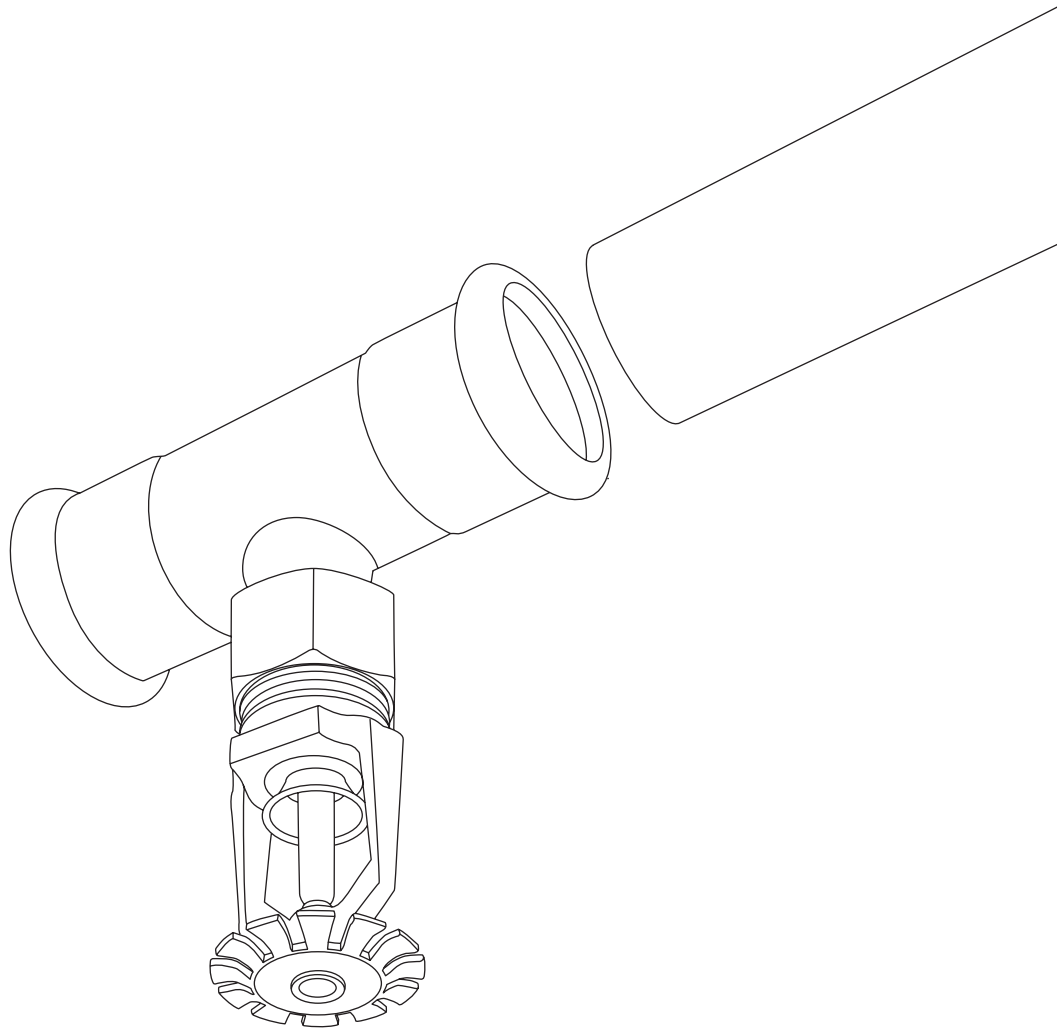

SYSTEM **KAN-therm**

Sprinkler

KAN-therm Sprinkler is a complete fire extinguishing installation system consisting of pipes and fittings made of zinc-plated carbon steel (Steel Sprinkler) or stainless steel (Inox Sprinkler) in 22–108 mm (Dn20 – DN100) diameter range.

Particular system elements are jointed using the state of the art, professional and, most of all, safe “Press” technique based on pressing fittings on the pipe using dedicated tools.

The KAN-therm Sprinkler System is designed for constructing indoor-use, fire-extinguishing sprinkler systems. Both material versions are verified and certified according to VdS guidelines for application in stationary sprinkler systems after emergency valves, within rooms characterized by low or medium fire hazard (LH, OH1, OH2, OH3, and to OH4 in respect to exhibition halls, cinemas, theaters and concert halls).

KAN-therm Sprinkler Systems are ideal for constructing new and replacing old, traditional fire-extinguishing sprinkler installations.

CONTENTS

5	Introduction
5	KAN-therm Sprinkler Features
6	KAN-therm Sprinkler System Application
7	“Press” coupling technique
8	LBP O-ring seal
9	KAN-therm System elastic hoses
10	KAN-therm Sprinkler System Tools
11	KAN-therm Sprinkler System - joints installation
14	General information regarding system installation
15	Tightness test
16	Transport and storage
16	General hydraulic dimensioning guidelines for KAN-therm Sprinkler systems
21	Application and operating conditions
22	System KAN-therm Steel Sprinkler - carbon steel pipes
23	System KAN-therm Steel Sprinkler - pressed carbon steel couplings
24	System KAN-therm Steel Sprinkler - assortment
37	Application and operating conditions
38	System KAN-therm Inox Sprinkler - stainless steel pipes
39	System KAN-therm Inox Sprinkler - pressed stainless steel couplings
40	System KAN-therm Inox Sprinkler - assortment
51	Index
53	Order
55	KAN in Europ

Introduction

As fire safety in newly created and renovated objects, as well as the pursue to minimize installation construction time become a big concern, innovative systems like KAN-therm Sprinkler appear as an obvious choice.

KAN-therm Sprinkler Features

There are many systems on the constructions market using conventional solutions, such as threading, welding and soldering. The advantages brought by applying „Press“ coupling technique, as compared to the above mentioned, have been already appreciated long ago.

It is the aesthetics of systems constructed using KAN-therm Sprinkler that is frequently the main reason for which architects and designers choose our products for constructing fire extinguishing mechanisms.



All elements of the system are manufactured in a modern plant, which allows us to guarantee unshaken quality and availability of our products. Use of the advanced technology of laser welding in the production process assures an absolute control of all elements. Fully automated tightness testing is an integral part of the laser welding process. All straight couplings with screwed ending are produced from one element, thanks to which the couplings' dimensions are limited to the minimum, just like the risk of occurrence of leaks. Thanks to an extraordinarily smooth surface of pipes and fittings, the obtained flow characteristics allow for a significantly increased efficiency, as compared to conventional solutions. The high quality of KAN-therm Sprinkler System has been confirmed by national and international certifying bodies.

Reliability

In KAN-therm System sprinkler systems, the quality of joint mainly depends on the tool used. This minimizes risk of human-caused assembly faults. To limit the risk of occurrence of human-caused assembly faults, all KAN-therm Sprinkler System fittings feature LBP (Leak Before Press) function, detecting non-pressed joints. For fittings of dimensions up to DN50, inclusive, the LBP functionality is assured by specific structure of the sealing O-ring; for elements of dimensions up to DN50, the fitting's stub pipe has been ovalized. The LBP function allows for occurrence of a distinct leakage from the pipe-fitting joint, if the joint has not been pressed. This makes it easy to quickly state which connections have not been pressed during installation, and perform the necessary repairs. After pressing the fitting on the pipe, tightness is guaranteed.

KAN-therm Sprinkler System advantages:

- quick and secure installation assembly, without the necessity of welding or screwing pipes (risk of working with open fire eliminated),
- wide range of pipe and fitting diameters - from 22 mm to 108 mm
- high aesthetics of the performed installations, without the necessity of painting
- small weight of pipes and fittings
- optimized fitting dimensions assure easier construction of the installation
- resistance to mechanical damage

The above features cause KAN-therm Sprinkler System to be easy and comfortable, not requiring specific skills.

KAN-therm Sprinkler System assembly takes place without use of open fire (as opposed to welding or soldering), or applying other heavy and potentially dangerous tools.

Thanks to the minimal requirements, KAN-therm Sprinkler System is a perfect solution for modernizations or renovations. Additionally, the small weight of KAN-therm Sprinkler pipes and fittings and their precision of making contribute to improvement of conditions and increase of work comfort.

Short KAN-therm Sprinkler System assembly time, as compared to conventional assembly systems, is a very important factor, decreasing costs related with investment execution.

We are convinced that the presented advantages encourage you to try KAN-therm Sprinkler System when designing and constructing sprinkler systems.

KAN-therm Sprinkler System Application

Stationary sprinkler installations are built-in fire extinguishing and prevention systems that independently detect and report fire, and automatically initiate the extinguishing process.

KAN-therm Sprinkler System assembly in sprinkler systems should be performed according to the applicable guidelines (e.g. VdS-CEA 4001 or PN-EN 12845+A2:2010).

Depending on the applied material (stainless steel or galvanized steel), the system may be used with water (wet) or dry stationary sprinkler systems. KAN-therm Sprinkler System is designed for use with only wet sprinkler systems, whereas KAN-therm Inox Sprinkler System may be applied

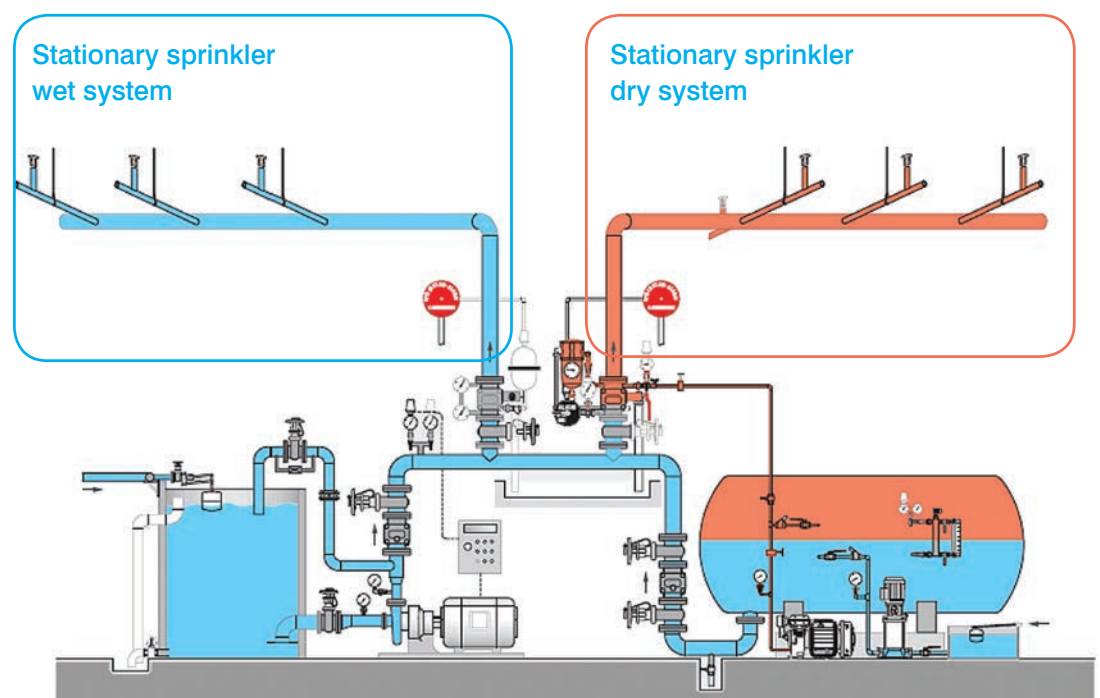

with wet, as well as dry stationary sprinkler systems.

KAN-therm Steel Sprinkler and KAN-therm Inox Sprinkler Systems have been tested and certified according to the VdS guidelines for application in stationary sprinkler installations equipped with emergency valve.

The following guidelines refer to all products comprising KAN-therm Sprinkler System, operating at working pressure stated in the below table:

Operating pressure in KAN-therm Sprinkler System

DN	internal ϕ [mm]	VdS	
		wet [bar]	wet and dry (stainless steel) [bar]
20	22	16	16
25	28	16	16
32	35	16	16
40	42	16	16
50	54	16	16
65	76,1	12,5	16
80	88,9	10	12,5
100	108	10	10

Application is limited exclusively to KAN-therm Sprinkler System original elements. Connecting elements other than the original (not included in the KAN-therm Sprinkler System offer) is permissible only on the condition of using detachable metal connections..

Assembly and installation of KAN-therm Sprinkler System may be performed only by qualified technical personnel, having formal qualifications for performing sprinkler system-related works. Requirements regarding assembly of stationary sprinkler installations are included in VdS-CEA 4001 or PN-EN 12845+A2:2010 guidelines. The company performing installation must assure conformity with the above guidelines.

“Press” coupling technique

The „Press“ coupling technique consists in pressing fittings on the pipe, using specialist power tools.

Tightness of the connections is assured by special O-Ring seals made of EPDM rubber resistant to high temperatures, and „M“ type clamping system (O-ring clamped in three spots). This guarantees long and reliable operation.

1. M” type clamp system
2. Joint before pressing
3. Joint after pressing

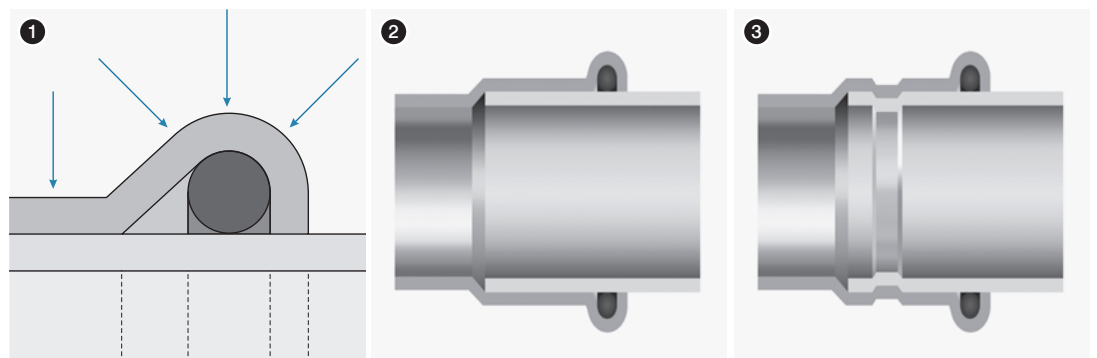

LBP O-ring seal

KAN-therm Sprinkler System pressed fittings are equipped with EPDM O-Rings of the following operating parameters:

Material	EPDM LBP (DN20 – DN50)	EPDM (DN65 – DN100)
Colour	black	black
Layer	without silicone, Teflon-based	without silicone, Teflon-based
Min./Max. temp.	-35°C to +135°C	-35°C to +135°C
Max. momentary operating press	150°C	150°C
Max. operating pressure	16 bar (depending on diameter - check application conditions for a given KAN-therm Sprinkler System)	16 bar (depending on diameter - check application conditions for a given KAN-therm Sprinkler System)
Application range	Wet and dry sprinkler systems	Wet and dry sprinkler systems

Thanks to special slots of the LBP O-ring body, optimum control of the system during pressure test is assured. The nonpressed joints are easy to locate, as they are not water tight. When pressing, the O-ring changes its shape, adhering entirely to pipe and fitting surface, assuring reliable and tight joint.



KAN-therm Sprinkler System also offers internal threaded elements that are used for connecting threaded elements from outside of the system (not comprising KAN-therm Sprinkler System), such as sprinklers, valves or other fixtures.

Internal and external threads are manufactured in compliance with DIN 2999/ISO 7/1 (taper thread). It is recommended to perform the threaded connection before pressing the fitting, not to stress the pressed joint. To tighten the joint, do not apply Teflon tapes or any other compounds containing chlorides.



KAN-therm System elastic hoses

KAN-therm System elastic hoses are covered by approval issued by VdS for stationary sprinkler systems. We offer two versions of hoses, equipped with straight or 90 degree-angled ending. The following dimensions are available: DN20 and DN25 of 800, 1000, 1500 mm lengths.

Elastic hoses designed for fitting in:

- ceiling systems with I-beams, covered with mineral cotton panels and metal cassettes (with fixation to main and auxiliary beams),
- ceiling systems with fixation profiles,
- ceiling systems of gypsum-cardboard panels,
- suspended standard sprinkler systems,
- enclosed sprinklers or sprinklers concealed in cavities.

Assembly of sprinkler lines using stiff pipe conduits in suspended ceilings may be very expensive and time consuming. Use of elastic hoses in sprinkler systems allows for easy and quick connection of sprinklers in any place in the area within the hose's length. Elastic hoses assure easy assembly of sprinklers in suspended ceilings, which saves time and costs.

The system comes with assembly holders, which allow for safe and reliable fixture of the sprinkler hose to the suspended ceiling.

The elastic hoses also feature pipe adapters, 100% compatible with KAN-therm Sprinkler. The pipe adapter assures easy connection of the elastic hose to installation performed in KAN-therm Sprinkler system, using Press fittings. In installations using twisted joints, in order to connect the elastic hose with pipe adapter, KAN-therm Sprinkler fitting must be used that has a thread (external/internal) on its one side, and a pressed ending on the other side. After screwing in the fitting, you only need to plug the hose to the pipe adapter and press the joint.

Features

- easy and quick assembly using standard KAN-therm Sprinkler, tools
- hose made of stainless steel
- allow for easy assembly in the vicinity of other installation and buildings' structural elements,
- no need for rotating the entire hose during assembly, thanks to using straight pipe ending,
- freedom of choice at selecting the system fixing the sprinklers along the ceiling plate
- no need for bending or lifting ceiling elements thanks to elastic structure of fixture between sprinkler hose and ceiling
- no need for disassembling and reassembling sprinkler systems during renovations or ceiling replacements. Hoses and holders (together with the installed sprinklers) may be disassembled and reassembled in a new place, without the need of emptying the entire installation (only within the hose length),
- easy vertical setting of the sprinkler thanks to a scale on the sprinkler's sleeve



Elastic hose technical specification

Sprinkler hose	Type RS 339L92, DN20/DN25, elastic braided structure, performed entirely of stainless steel, welded joints.
Sprinkler joint (straight)	Stainless steel, pipe thread complying with DIN EN 10226 (ISO 7/1), Rp 1/2 „(SW 27). Scale for easy vertical set-up Application for installation in limited spaces. Installation height only 170 mm above the lower edge of a suspended ceiling
Sprinkler joint (angular, 90°)	Stainless steel, pipe thread complying with DIN EN 10226 (ISO 7/1), Rp 1/2 „(SW 27). Scale for easy vertical set-up Application for installation in limited spaces Installation height only 170 mm above the lower edge of a suspended ceiling
Connection adapter	Stainless steel, straight ending, 22 or 28 mm diameter for connecting with KAN-therm Sprinkler System connectors
Nominal length	800, 1000, 1500 mm
Max. operating pressure	16 bar, 100% tightness control
Minimum bend radius	70 mm for Ø22 hoses; 85 mm for Ø28 hoses

KAN-therm Sprinkler System Tools

Pressing of the KAN-therm Sprinkler fittings should be performed using pressing units and press jaws („M” profile) delivered by KAN-therm Sprinkler System.

Name	Permissible pressed diameters range	Power type
ECO 301	22–54 mm	220 – 240 V / 50 Hz, stationary feed
ACO 401	76-108 mm	18,0V / 3,0 Ah, battery feed

In case of pressing fittings of 35-54 mm diameter for ECO 301 pressing units, an additional ZB 303 adapter should be used, to fix the snap-on jaw.

Depending on the diameter, KAN-therm provides various configuration of tools. In order to select optimal set of tools, please follow chart:

Selection of tools table: System KAN-therm Sprinkler Steel & Inox

Producer	Type crimp tool		Diameter [mm]	Jaws/clamping chains		Adapter		KAN-therm System		
	Description	Code		Description	Code	Description	Code	Steel Sprinkler	Inox Sprinkler	
NOVOPRESS	ECO301	620570.5	22	M22	620575.1	–	–	+	+	
			28	M28	620576.0	–	–	+	+	
			35	HP 35 Snap On	634106.0				+	+
			42	HP 42 Snap On	634107.1	ZB 303	634111.5		+	+
			54	HP 54 Snap On	634108.2				+	+
ACO401	634008.1	76,1	HP 76,1	634009.2	–	–	+	+		
		88,9	HP 88,9	634010.3	–	–	+	+		
		108	HP 108	634011.4	–	–	+	+		

Tools NOVOPRESS:



Novopress ECO 301



22-28 mm jaw



Press collar HP 35 Snap On



Press collar HP 42, HP 54 Snap On



Adapter ZB 303 35-54mm



ACO 401 machine



Press collar HP 76,1 - 108

KAN-therm Sprinkler System - joints installation



1 Cutting pipes

Pipes must be cut perpendicularly to the axis, using pipe cutter. It is acceptable to use other cutting tools such as manual or electrical saw for metal, if perpendicularly of cutting is maintained, and the edges are not damaged. It is not acceptable to break partially cut pipes. Do not use burners or cutting wheel for cutting.

While measuring the cutting length, depth of fitting must be considered.

2 Beveling

Beveling should be performed using manual or electrical beveling machine. Bevel the external and internal edge of the cut pipe, so that it does not damage the O-ring. Also, remove all contamination from within the pipe, which may increase the risk of corrosion.

Fig. 3A – A - pipe insert depth, d_{min} - minimum installation distance between fittings

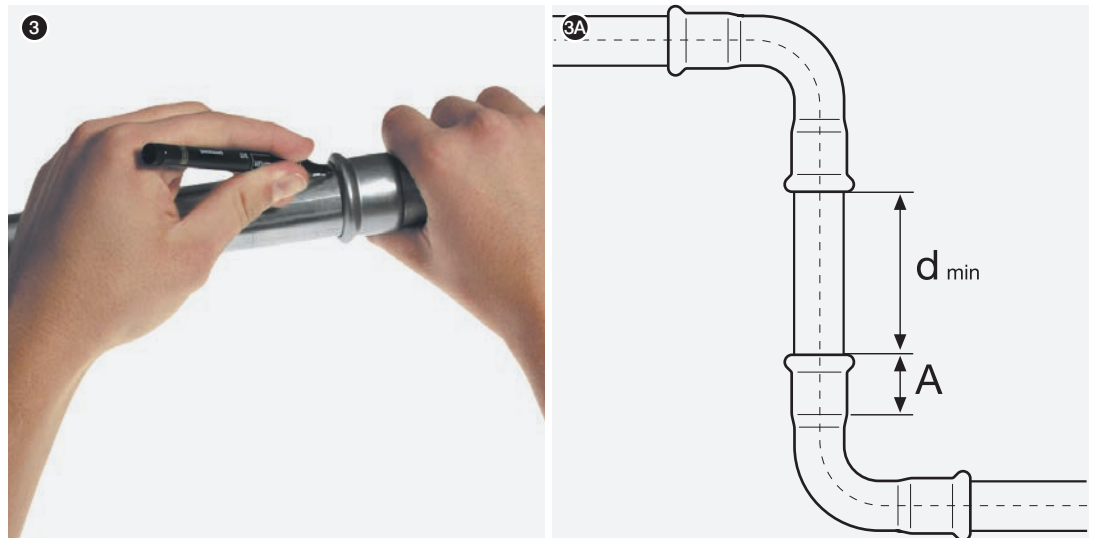

3 Marking the insert depth

To achieve sufficient joint strength, maintain sufficient insert depth (table 1, fig. 1). The sufficient insert distance should be marked on the pipe (or the fitting) with a marker. After performing the pressing, the marking must still be visible just by the fitting's edge. Appropriate insert depth is crucial for resistance of joint for stretching, after pressing the O-ring,

Tab.1 Pipe insert depth and minimum installation spaces

DN	∅ ext..	Insert depth	Minimum distance between two pressed joints	Minimum pipe length
	[mm × mm]	A [mm]	d_{min} [mm]	$d_{min} + 2 \times A$ [mm]
20	22×1,2	21	10	52
25	28×1,2	23/46*	10	62
32	35×1,5	26/52*	10	80
40	42×1,5	30/60*	20	90
50	54×1,5	35/70*	20	90
65	76,1×2,0	55/54*	40	165
80	88,9×2,0	63/64*	50	186
100	108×2,0	77/74*	60	234

* applies to Groove type couplings

Control

- 4 Before the installation, visually inspect the condition and presence of the appropriate O-Ring. Check whether there is no contamination (filings) on the pipe and in the fitting that may damage the sealing when inserting the pipe. Also, check if the pipe ending is not deformed and the section is perfectly circular. Make sure that the distance between neighbouring fittings is not smaller than the permissible value (d_{min}).

Installing pipe and fitting

- 5 Before pressing, insert the pipe into the coupling for a marked depth (small rotation is acceptable). Applying oils, greases or fats for facilitating the insertion process



is not allowed (water or soap solution is acceptable - recommended in case of compressed air pressure test)

Non-axial insertion of pipe is not allowed, as it exposes the sealing to damage. In case of simultaneously installing multiple joints (by inserting pipes into fittings), before pressing each joint, control the insertion depth

Installation distances

During the system installation, structure and dimensions of jaws should be considered, minimum installation distances between pipes and structural cavities, basing on values specified in the table and on images, should be maintained.

Tab. 2 Installation distances

DN	Ø ext..	Fig. A		Fig. B		Fig. C	
		a	b	a	b	c	Pipe stand-off from wall distance [mm]
20	22×1,2	65	25	80	31	35	40
25	28×1,2	75	25	80	31	35	60
32*	35×1,5	115	75	115	75	75	70
40*	42×1,5	120	75	115	75	75	70
50*	54×1,5	200	85	120	85	85	70
65*	76,1×2,0	250	170	200	170	190	80
80*	88,9×2,0	250	170	250	170	210	90
100*	108×2,0	250	170	250	170	210	100

*applies to snap-on jaws

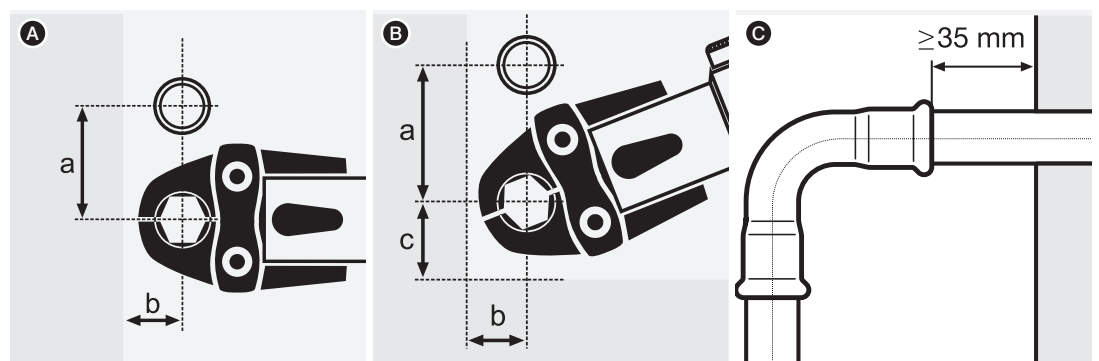



6 Pressing

Before pressing, prepare all tools and check for contamination. Press jaw size should always be adjusted to the diameter of the performed joint. Press jaw should be applied on the coupling in such way that its cavity precisely covers the convex section of the fitting (place of putting the O-ring on the fitting) After running the pressing unit, the pressing takes place automatically and may not be stopped. If, for any reason, the pressing is stopped, the joint must be disassembled (cut out) and a new one should be performed. Non-pressed joints, thanks to the special O-ring structure (LBP function) will be signalled already during filling the system with water. After locating the leak, just perform the pressing.

Pipe bending (for diameters up to Ø28)

If needed, „cold“ bending may be performed, on the condition of maintaining minimum bend radius R_{min} :

$$R_{min} \geq 3,5 \times D$$

For bending pipes, use manual, hydraulic or electrical bender. The pipes should not be „hot“ bent.

Twisted joints

KAN-therm Sprinkler system also includes external and internal thread elements, which serve the purpose of connecting other threaded elements of the system (such as sprinklers, valves or other). External and internal threads are manufactured according to DIN 2999/ISO 7/1 (taper thread) It is recommended to perform the screwed connection before pressing the fitting, not to stress the pressed joint.

General information regarding system installation

Fitting pipelines

While installing KAN-therm Sprinkler System, care must be taken not to overstress the pipelines network, while standby, as well as during an emergency. A/C channels or cable racks should not be placed above the sprinkler pipe.

In case if design or structural reasons make it impossible to avoid the sprinkler pipe crossing other system elements, such as

A/C channels or cable racks, the sprinkler system should be secured from overstressing, using

additional, certified fixture elements.

The required space between fixtures is provided in the table. Fixture distance from pipe ending must not exceed 90 cm.

1 Example of fixing the fixtures at a crossing with installations (cable rack).

2 Example of fixing the fixtures at a crossing with installations (duct).

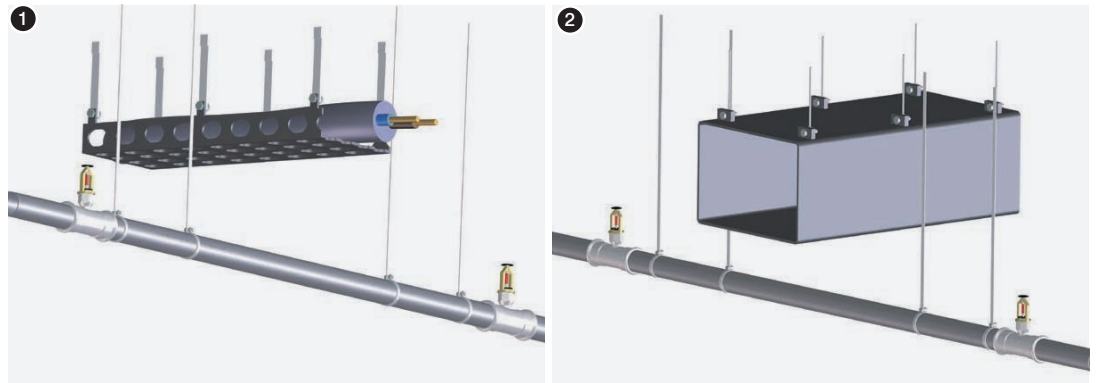

DN	Pipe dimensions External Ø[mm]	Fixtures spacing [m]	
		DIN 1988-2	CEA 4001 (VdS)
20	22	2,00	2,00
25	28	2,25	2,00
32	35	2,75	2,00
40	42	3,00	2,00
50	54	3,50	2,00
65	76,1	4,25	2,00
80	88,9	4,75	2,00
100	108	5,00	2,00

KAN-therm Sprinkler pipe holder separation distances apply only, if there are no other installations (pipelines, channels) above the sprinkler system pipe.

There should be at least one holder within at least 0,9 m from each joint. Each pipe section should be held by at least one holder. The fixtures must be designed and constructed in conformity with PN-EN 12845+A2:2010.

Pipeline flushing

After performing the installation, the entire sprinkler system must be thoroughly flushed with drinkable water. The flushing is necessary for assuring proper operation of the sprinkler system and protecting it from contamination. After flushing, the installation should be emptied. After removing all materials required for flushing, sprinklers should be installed.

Filling and deaerating pipe networks

After flushing the pipelines, they must be filled with filtered drinkable water and completely deaerated.

Tightness test

Pipelines of the sprinkler system must be pressure tested, in conformity with applicable guidelines, such as CEA 4001, no.17.1.1. (VdS). The test should last at least two hours at a pressure (measured at emergency valves) being a 1,5 multiple of admissible operating pressure, but not smaller than 15 bar. Pressure decrease, e.g. due to meteorological factors, must be monitored at 24h basis.

Dry sprinkler installations must be pneumatic tested for pressure not smaller than 2,5 bar for a

period of at least 24 hours. Each leak that causes a decrease of pressure greater than 0,15 bar for a period of at least 24 h, must be sealed. All detected defects, such as permanent deformations, breaks or leaks must be fixed and be tested again.

Transport and storage

When transporting and storing KAN-therm Sprinkler System pipes and pressed fittings, they should be kept away from damage or contamination hazards.

KAN-therm Sprinkler System elements should not be stored together with elements of other metal systems.

It is not allowed to store system elements directly on the ground (concrete or earth).

It is not allowed to store the elements in direct vicinity of chemical compounds.

Pipe bundles should be stored and transported on wooden or plastic pads (avoid direct contact with other steel elements, such as steel pipe racks).

To avoid ovalization of pipes, it is recommended to form piles not higher than 6 bundles. During transport, loading and unloading, avoid scratching or else mechanically damaging pipes and fittings - do not: throw, pull and bend.

Rooms for storing the elements must be dry (maximum permissible relative humidity must not exceed 65%). Recommended temperature for storage is within 10 to 25 dgr. C.

External pipe surfaces during storage, construction and operation must not be exposed to extensive and direct contact with humidity.

General hydraulic dimensioning guidelines for KAN-therm Sprinkler systems

Pressure losses

To calculate pressure loss in pipe network of sprinkler systems, Hazen-Williams formula should be applied.

$$p = \frac{6,05 \times 10^5}{C^{1,85} \times d^{4,87}} \times Q^{1,85} \times L$$

where:

p – linear pressure loss [bar]

Q – flow intensity [l/min]

d – internal pipe diameter

C – pipe constant, for KAN-therm Steel and Inox Sprinkler systems C=140

L – substitute length for pipes and fittings [m]

The formula covers linear losses on the length of the calculated section of the pipelines, as well as local losses in form of equivalent (substitute) lengths for fittings and fixtures (values of substitute lengths for fittings are shown in table below).

Designing and hydraulic dimensioning principles for sprinkler systems is defined by PN-EN 12845+A2:2010 standard. Stationary fire extinguishing units. Automatic sprinkler systems. Design, assembly and maintenance.



Ø22 – 54 mm

Local resistance coefficients ζ

ζ	1,5	0,7	0,5	0,5	0,4	0,9	1,3	1,5	3,0
---------	-----	-----	-----	-----	-----	-----	-----	-----	-----

Equivalent lengths of fittings [m]

22	1,40	0,60	0,50	0,50	0,40	0,80	1,20	1,40	2,80
28	1,90	0,90	0,60	0,60	0,50	1,10	1,50	1,90	3,80
35	2,50	1,20	0,80	0,80	0,70	1,50	2,10	2,50	5,00
42	3,10	1,40	1,00	1,00	0,90	1,80	2,60	3,10	6,20
54	4,00	1,80	1,30	1,30	1,10	2,30	3,30	4,00	8,00

Ø76,1- 108 mm local resistance coefficient ζ

	1,3	0,6	0,4	0,5	0,1	1,0	1,3	1,5	3,0
--	-----	-----	-----	-----	-----	-----	-----	-----	-----

Equivalent lengths of fittings [m]

76,1	6,10	2,80	1,90	2,40	0,50	4,70	6,10	7,10	14,20
88,9	7,80	3,60	2,40	3,00	0,60	6,00	7,80	9,00	18,0
108	10,6	4,90	3,30	4,10	0,80	8,20	10,60	12,30	24,60

Length (mm)	Sprinkler joint type	Sprinkler connector	Outside ϕ (mm)	Pressure losses* (bar)	Equiv. pipe length*(m)
1000	straight	Rp 1/2"	Ø22	0,9	8
1500	straight	Rp 1/2"	Ø22	1,3	12
1000	straight	Rp 1/2"	Ø28	0,5	8
1500	straight	Rp 1/2"	Ø28	0,8	11
800	degree 90°	Rp 1/2"	Ø22	0,8	8
1000	degree 90°	Rp 1/2"	Ø22	0,9	8
1500	degree 90°	Rp 1/2"	Ø22	1,3	12
800	degree 90°	Rp 1/2"	Ø28	0,5	8
1000	degree 90°	Rp 1/2"	Ø28	0,5	8
1500	degree 90°	Rp 1/2"	Ø28	0,8	11

Tab 3. Pressure losses in elastic hoses and equivalent pipe lengths corresponding to VdS specifications



Safety for years to come



SYSTEM **KAN-therm**

Steel Sprinkler

Technical information.
Pricelist



TECHNOLOGY OF SUCCESS



ISO 9001



Application and operating conditions

KAN-therm Inox Sprinkler System is designed for constructing pipelines (distributing or splitting conduits) of stationary air or water sprinkler systems installed in small or medium fire hazard areas (LH, OH1, OH2, OH3 and up to OH 4 - in reference to exhibition rooms, theatres and concert halls) (according to VdS CEA 4001 guidelines)

Application in other fire extinguishing systems and dry sprinkler systems is prohibited.

The system's pipes and fittings are approved by the CNBOP (Fire Protection Science and Research Center) with AT-1106- 0227/2009 ID and VdS certificate.

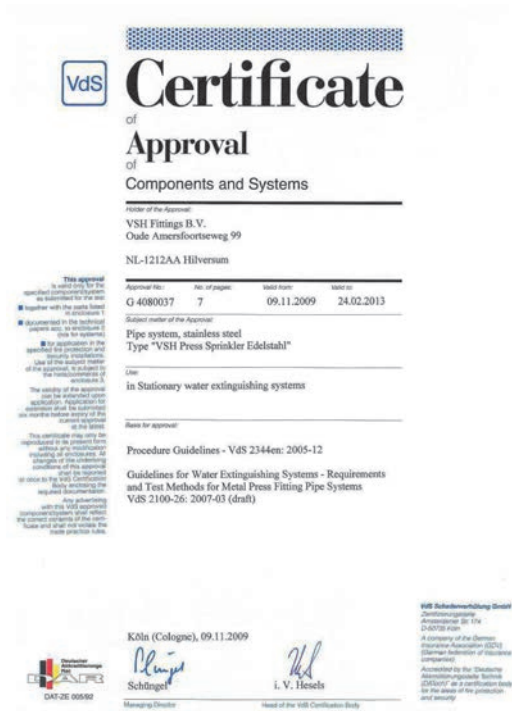

The installation should be designed and constructed according to guidelines included in this document, as well as with applicable standards and regulations.

Designing, assembly and commissioning of the sprinkler system is defined by PN-EN 12845:2008 standard. Stationary fire extinguishing units. Automatic sprinkler units Design, assembly and maintenance

Maximum operating pressure of the pipes and fittings is:

- for 22 - 54 diameters 16,0 bar
- for 76,1 diameter 12,5 bar
- for 88,9 and 108 diameter 10,0 bar.

System KAN-therm Steel Sprinkler - carbon steel pipes



KAN-therm Steel Sprinkler System pipes for water sprinkler installations are precise carbon steel no. 1.0031 (EN10305-3 compliant) pipes. They are made of cold rolled strip, galvanized using the Sendzimir method of coating the metal plate with zinc by immersing it in electrolytic zinc, after which the zinc is applied on both sides simultaneously. This means the pipe is protected by zinc layer on inside and outside. The zinc layer is never less than 20 μm thick. The Sendzimir galvanization is known for guaranteeing particularly good adherence and high resistance to corrosion.

Fire environment properties

KAN-therm Steel Sprinkler System carbon steel pipes may be classified as class A incombustible materials, according to DIn 4102, part 1.

Technical details of pipes

DN	Outside diameter x wall thickness	Inside diameter	Unit mass	Water capacity
	mm x mm	[mm]	[kg/m]	[kg/m]
20	22 x 1,5	19,0	0,761	0,284
25	28 x 1,5	25,0	0,980	0,491
32	35 x 1,5	32,0	1,241	0,804
40	42 x 1,5	39,0	1,542	1,195
50	54 x 1,5	51,0	1,999	2,043
65	76,1 x 2,0	72,1	3,503	4,083
80	88,9 x 2,0	84,9	4,412	5,661
100	108 x 2,0	104,0	5,382	8,495

KAN-therm Steel Sprinkler for sprinkler systems pipe dimensions

Material	ULC („Ultra Light Carbon“) galvanized (Sendzimir method) material no. 1.0031 acc. to EN 10305-3
Outside diameter tolerance	acc. to EN10305-3
Thermal expansion coefficient	0,0108 mm/m at $\Delta T = 1 \text{ K}$
Minimum bend radius (for diameters up to $\text{Ø}28 \text{ mm}$)	3,5 x pipe outside diameter (up to -10°C)
Delivery	6 m \pm 50 mm lengths
Marking	name or manufacturer label, material identification outside diameter x wall thickness, approval no., manufacture date
Zinc layer	at least 20 μm . The pipe joints are extra galvanized.
Max. operating pressure	16 bar (22-54 mm); 12,5 bar (76,1 mm); 10 bar (88,9-108 mm)

System KAN-therm Steel Sprinkler - pressed carbon steel couplings

KAN-therm Steel Sprinkler System pressed couplings are made of material no. 1.0034 [34-2 steel] carbon steel. They are rust protected by the applied zinc layer (8-15 μm) The couplings are equipped with EPDM rubber sealing ring (O-ring)

The DN20 - 50 O-rings feature non-pressed joints detection function (Leak Before Press).

Coupling diameter range DN20 - DN100



System KAN-therm Steel Sprinkler - assortment

press carbon steel pipe, zinc coated

GROUP: J

Size	*	Code	Pcs.	Ilość m w op. zbiorczych
22×1,5		6241114S	bar 6m	6/360
28×1,5		6241125S	bar 6m	6/300
35×1,5		6241136S	bar 6m	6/180
42×1,5		6241147S	bar 6m	6/150
54×1,5		6241158S	bar 6m	6/90
76,1×2		6241378S	bar 6m	6/-
88,9×2		6241389S	bar 6m	6/-
108×2		6241391S	bar 6m	6/-



press male connector

GROUP: I

Size	l	z	*	Code	Pcs. /packing
22×R1/2	43	22		6241015S	6241015S
22×R3/4	44	23		6240135S	6240135S
22×R1	50	29		6241026S	6241026S
28×R3/4	46	23		6249852S	6249852S
28×R1	48	25		6240146S	6240146S
35×R1	53	27		6341247S	6341247S
35×R1 1/4	55	29		6240157S	6240157S
42×R1 1/2	59	29		6240168S	6240168S
54×R2	69	34		6240179S	6240179S
76,1×R2 1/2	123	68	**	6302823S	6302823S
88,9×R3	134	71	**	6302825S	6302825S

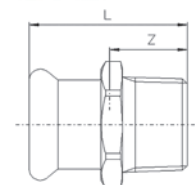

press male union connector

GROUP: I

Size	l	z	*	Code	Pcs. /packing
22×R3/4	70	49,0		6240916S	2/40
28×R1	74,7	51,7		6240927S	2/30
35×R1 1/4	81,8	55,8		6240938S	2/20
42×R1 1/2	88	58,0		6240949S	2/16
54×R2	100	65,0		6240951S	2/10

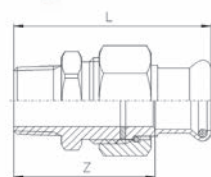

press half union

GROUP: I

Size	l	z	*	Code	Pcs. /packing
22×G1	32	11	**	6340554S	10/60
28×G1 1/4	33	10	**	6340565S	10/40
35×G1 1/2	36	10	**	6340576S	4/32
42×G1 3/4	43	13	**	6340587S	4/12
54×G2 3/8	50	15	**	6340598S	4/8

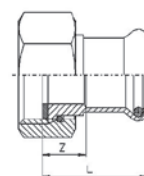

* on request – (delivery time up to 4 weeks)

** availability by individual arrangements

*** till stock ends

press female connector

GROUP: I

Size	l	z	*	Code	Pcs. /packing
22×Rp½	36,5	4,5		6302708S	10/100
22×Rp¾	43	5,7		6240102S	10/100
28×Rp½	38	2		6240113S	10/60
28×Rp¾	40,5	1		6249830S	10/60
28×Rp1	49	7		6240124S	10/60
35×Rp½	42	5,3	**	6340917S	10/40
35×Rp1¼	43	5,2	**	6340928S	10/40
35×Rp1	46	7	**	6340939S	10/40
35×Rp1¼	50	2,3		6241004S	10/30
42×Rp1½	54	2		6302721S	10/40
54×Rp2	63	2		6302723S	10/40

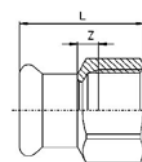

press nipple female connector

GROUP: I

Size	A	Z	D	*	Code	Pcs. /packing
22×Rp½	50	35,0	22		6240960S	10/70
22×Rp¾	53	36,7	22		6240971S	10/100

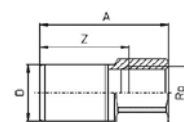

press coupling

GROUP: I

Size	l	z	*	Code	Pcs. /packing
22×22	55	13		6240003S	10/80
28×28	59	13		6240014S	10/60
35×35	65	13		6240025S	10/40
42×42	76	16		6240036S	4/24
54×54	86	16		6240047S	4/16
76,1×76,1	142	28		6206200S	2/-
88,9×88,9	160	34		6206211S	2/-
108×108	199	41		6206222S	2/-

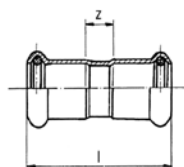

press slip coupling

GROUP: I

Size	l	z	*	Code	Pcs. /packing
22×22	84	25		6240058S	10/60
28×28	91	30		6240069S	10/40
35×35	102	30		6240071S	10/20
42×42	120	40		6240080S	4/16
54×54	140	40		6240091S	4/8
76,1×76,1	230	60		6206233S	2/-
88,9×88,9	262	70		6206244S	2/-
108×108	304	80		6206255S	2/-

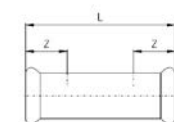

* on request – (delivery time up to 4 weeks)

** availability by individual arrangements

*** till stock ends

press 90° elbow

GROUP: I

Size	l	z	*	Code	Pcs. /packing
22×22	51	30		6240181S	10/60
28×28	60	37		6240190S	10/30
35×35	71	45		6240201S	10/10
42×42	86	56		6240212S	2/16
54×54	105	70		6240223S	2/8
76,1×76,1	150	95		6208004S	2/-
88,9×88,9	174	111		6208048S	2/-
108×108	215	139		6208059S	2/-

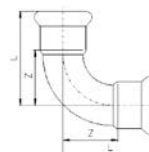

press nipple 90° elbow

GROUP: I

Size	l	z	h	*	Code	Pcs. /packing
22×22	51	30	58,1		6240410S	10/60
28×28	60	37	65,5		6240421S	10/30
35×35	71	45	75,9		6240432S	10/10
42×42	86	56	92,5		6240443S	2/8
54×54	105	70	110,6		6240454S	2/6
76,1×76,1	150	94	166		6208061S	2/-
88,9×88,9	174	109	190		6208070S	4/-
108×108	215	122	230		6208081S	4/-

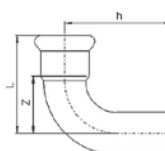

press 45° elbow

GROUP: I

Size	l	z	*	Code	Pcs. /packing
22×22	35,2	14,2		6240511S	10/70
28×28	40,1	17,1		6240520S	10/40
35×35	46,4	20,4		6240531S	5/25
42×42	56,1	26,1		6240542S	2/16
54×54	66,9	31,9		6240553S	2/8
76,1×76,1	98	43		6208125S	4/-
88,9×88,9	113	50		6208136S	4/-
108×108	138	62		6208147S	2/-



press nipple 45° elbow

GROUP: I

Size	l	z	h	*	Code	Pcs. /packing
22×22	35,2	14,2	42,3		6240465S	10/60
28×28	40,1	17,1	45,6		6240476S	10/40
35×35	46,4	20,4	51,3		6240487S	5/25
42×42	56,1	26,1	62,6		6240498S	4/16
54×54	66,9	31,9	72,5		6240509S	2/8
76,1×76,1	96	41	119		6208092S	2/-
88,9×88,9	110	47	130		6208103S	2/-
108×108	137	61	160		6208114S	2/-

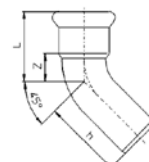

* on request – (delivery time up to 4 weeks)

** availability by individual arrangements

*** till stock ends

press tee

GROUP: I

Size	l1	z1	l2	z2	*	Code	Pcs. /packing
22×22×22	39,5	18,5	48,5	27,5		6240564S	10/40
28×28×28	44,5	21,5	53,5	30,5		6240575S	10/30
35×35×35	51	25	60	34		6240586S	5/15
42×42×42	60	30	66,5	36,5		6240597S	4/8
54×54×54	71	36	77,5	42,5		6240608S	2/6
76,1×76,1×76,1	116	61	121	61		6206442S	2/-
88,9×88,9×88,9	131	68	126	63		6206453S	2/-
108×108×108	152,0	78	152	74		6206464S	2/-

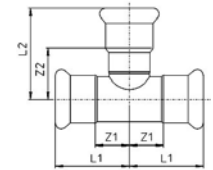

press reducing tee

GROUP: I

Size	l1	z1	l2	z2	*	Code	Pcs. /packing
22×28×22	39,5	18,5	52	29		6240718S	10/40
28×22×28	44,5	21,5	51,5	30,5		6240729S	10/30
35×22×35	51	25	55	34		6240731S	5/20
35×28×35	51	25	57	34		6240740S	10/20
42×22×42	60	30	57,5	36,5		6240751S	4/12
42×28×42	60	30	59,5	36,5		6240762S	4/12
42×35×42	60	30	62,5	36,5		6240773S	4/12
54×22×54	71	36	63,5	42,5		6240784S	2/8
54×28×54	71	36	65,5	42,5		6240795S	2/8
54×35×54	71	36	68,5	42,5		6240806S	2/8
54×42×54	71	36	72,5	42,5		6240817S	2/8
76,1×22×76,1	116	61	79	47	**	6303371S	2/-
76,1×28×76,1	116	61	80	43	**	6303373S	2/-
76,1×35×76,1	131	68	75,5	51,5	**	6303375S	2/-
76,1×42×76,1	131	68	83	56,5	**	6303377S	2/-
76,1×54×76,1	131	68	85	53		6206475S	2/-
88,9×22×88,9	131	68	92,5	55,5	**	6303379S	2/-
88,9×28×88,9	131	68	128	73	**	6303381S	2/-
88,9×35×88,9	156	78	135	72	**	6303383S	2/-
88,9×42×88,9	156	78	85	62	**	6303385S	2/-
88,9×54×88,9	156	78	87,5	63,5	**	6303387S	2/-
88,9×76,1×88,9	156	78	93,5	66		6206486S	2/-
108×22×108	156	78	96	64	**	6303389S	2/-
108×28×108	156	78	102	65	**	6303391S	2/-
108×35×108	156	78	125	70	**	6303393S	2/-
108×42×108	131	68	76	53	**	6303395S	2/-
108×54×108	116	61	68	45	**	6303397S	2/-
108×76,1×108	116	61	71	47	**	6303399S	2/-
108×88,9×108	116	61	75	48		6206497S	2/-

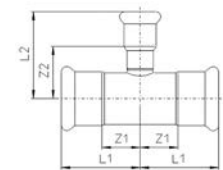

* on request – (delivery time up to 4 weeks)

** availability by individual arrangements

*** till stock ends

press pipe cross 90°

GROUP: I

Size	h	l1	z1	l2	z2	*	Code	Pcs. /packing
28×22×22×28	31	22	19	45	40		6240828S	10/20

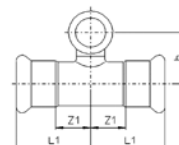
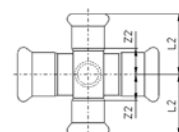

press crossing

GROUP: I

Size	l1	z1	l2	z2	*	Code	Pcs. /packing
35×35×35×35	51,5	60	25,3	33,8	**	6340972S	2/8
42×42×42×42	60,7	66,5	30,4	36,3	**	6340983S	2/8
54×54×54×54	71	77,5	36	42,5	**	6340994S	-/4
35×28×35×28	51,5	57	25,3	33,7	**	6341005S	2/14
42×28×42×28	60,7	59,5	30,4	36,2	**	6341016S	2/8
54×28×54×28	71	65,5	36	42,2	**	6341027S	-/4

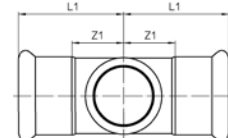
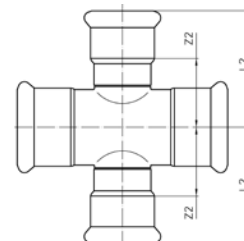

press nipple reducer

GROUP: I

Size	l	z	d1	d2	*	Code	Pcs. /packing
28×22	63	42	28	22		6240234S	10/80
35×22	68	47	35	22		6240245S	10/50
35×28	69	46	35	28		6240256S	10/60
42×22	80	59	42	22		6246651S	5/30
42×28	79	56	42	28		6240267S	5/30
42×35	76	50	42	35		6240278S	4/24
54×22	89	68	54	22		6240289S	4/16
54×28	87	64	54	28		6240291S	4/16
54×35	89	63	54	35		6240300S	10/30
54×42	91	61	54	42		6240993S	4/16
76,1×42	151	121	76,1	42		6206387S	2/-
76,1×54	145	109	76,1	54		6206398S	2/-
88,9×54	157	122	88,9	54		6206409S	2/-
88,9×76,1	157	105	88,9	76,1		6206411S	2/-
108×76,1	196	144	108	76,1		6206420S	2/-
108×88,9	192	133	108	88,9		6206431S	2/-

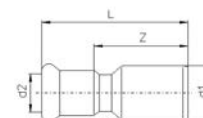

* on request – (delivery time up to 4 weeks)

** availability by individual arrangements

*** till stock ends

press male elbow

GROUP: I

Size	b	z	a	*	Code	Pcs. /packing
22×R¾	61,5	30	51		6240366S	10/60
28×R1	73,5	37	60		6240377S	10/30
35×R1¼	85,5	45	71		6240388S	10/10
42×R1½	95,5	56	86		6240399S	4/12
54×R2	115,5	70	105		6240401S	2/8

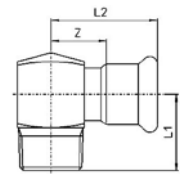

press male elbow - short

GROUP: I

Size	l2	z	l1	*	Code	Pcs. /packing
22×R¾	44,5	23,5	32		6240982S	10/60

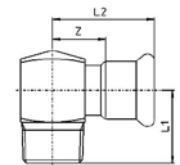

press female elbow 90°

GROUP: I

Size	l2	z	l1	*	Code	Pcs. /packing
22×Rp½	59	30	51		6249577S	10/30
22×Rp¾	59	30	51		6240964S	10/30
28×Rp½	65	37	60		6241169S	5/30
28×Rp¾	65	37	60		6241171S	5/30
28×Rp1	69,5	37	60		6249588S	5/30
35×Rp½	74,5	45	71		6241180S	5/10
35×Rp¾	74,5	45	71		6241061S	5/10
35×Rp1	74,5	45	71		6249599S	5/10

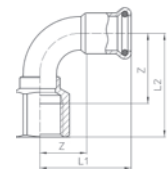

press female elbow - short

GROUP: I

Size	l1	l2	z1	z2	*	Code	Pcs. /packing
22×Rp½	31	44,5	16	23	**	6340972S	10/50
28×Rp½	35	50,5	20	26,7	**	6340983S	5/30
35×Rp½	35	56,5	20	29,4	**	6340994S	5/10

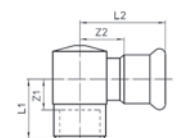

* on request – (delivery time up to 4 weeks)

** availability by individual arrangements

*** till stock ends

press female tee

GROUP: I

Size	l1	z1	l2	z2	*	Code	Pcs. /packing
22×Rp½×22	39,5	18,5	39	24		6240619S	10/50
22×Rp¾×22	39,5	18,5	41	24,7		6240621S	10/40
28×Rp½×28	44,5	21,5	42	27		6240630S	10/30
28×Rp¾×28	44,5	21,5	44	27,7		6240641S	10/30
28×Rp1×28	44,5	21,5	46	27,5		6249601S	10/30
35×Rp½×35	51	25	45,5	30,5		6240652S	10/20
35×Rp¾×35	51	25	47,5	31,2		6240663S	10/20
35×Rp1×35	51	25	50	31		6249610S	10/20
42×Rp½×42	60	30	48	33		6240674S	4/16
42×Rp¾×42	60	30	50	33,7		6240685S	4/16
42×Rp1×42	60	30	52,5	33,5		6249621S	4/16
54×Rp½×54	71	36	54	39		6240696S	2/8
54×Rp¾×54	71	36	56	39,7		6240707S	2/8
54×Rp1×54	71	36	60	41		6241070S	2/8
76,1×Rp¾×76,1	116	61	69	52		6206508S	2/-
88,9×Rp¾×88,9	131	68	76	59		6206519S	1/-
108×Rp¾×108	156	78	86	69		6206521S	1/-

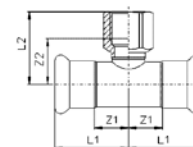

crossover

GROUP: I

Size	l	a	b	*	Code	Pcs. /packing
22×22	64,5	177	37		6240883S	10/50
28×28	75	215	43		6240894S	10/20

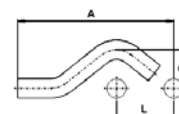

bend 90°

GROUP: I

Size	l1	z1	l2	z2	*	Code	Pcs. /packing
22×22	72	70	120	70		6240839S	10/40
28×28	82	80	120	80		6240841S	10/20
35×35	120	100	200	100		6240850S	4/8
42×42	150	120	250	120		6240861S	2/4
54×54	200	145	300	145		6240872S	2/2

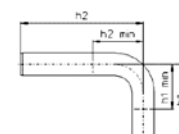

press flange PN16

GROUP: I

Size	DN	z	d	h	k	b	d2	otwory	*	Code	Pcs. /packing
76,1	65	79	185	134	145	18	18	4		620659.6S	4/-
88,9	80	78	200	141	160	20	18	8		620660.7S	2/-
108	100	88	220	166	180	20	18	8		620661.8S	2/-

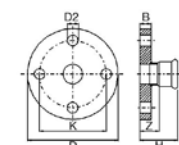

* on request – (delivery time up to 4 weeks)

** availability by individual arrangements

*** till stock ends

press cup

GROUP: I

Size	l	z	*	Code	Pcs. /packing
22	28,5	7,5		6240311S	10/240
28	32,3	9,3		6240322S	10/130
35	34,4	8,4		6240333S	5/75
42	43,2	13,2		6240344S	4/48
54	51,8	16,8		6240355S	4/32
76,1	70	15		6206915S	4/-
88,9	87	24		6206926S	4/-
108	98	21		6206937S	4/-

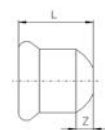

groove connector

GROUP: I

Size	l	D	Z	*	Code	Pcs. /packing
28×33,7	72,5	33,7	26	**	624130.1S	10/30
35×42,4	81	42,4	26	**	624134.5S	10/30
42×48,3	86	48,3	26	**	624135.6S	5/20
54×60,3	96,5	60,3	26	**	624136.7S	5/15
76,1×76,1	90	76,1	36	**	6340774S	2/-
88,9×88,9	100	88,9	36	**	6340785S	2/-
108×114	110	114,3	36	**	6340796S	2/-

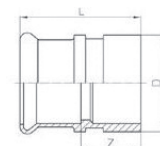

long press female connector

GROUP: I

Size	l	A	B	*	Code	Pcs. /packing
22×Rp½	92	25	15	**	624131.2S	10/60
22×Rp¾	97	25	16	**	624132.3S	10/60
28×Rp½	94	30	15	**	624126.8S	10/40
28×Rp¾	93	30	16	**	624127.9S	10/40

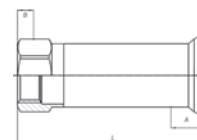

O-Ring LBP EPDM

GROUP: I

Size	*	Code	Pcs. /packing
22		6222238	20/500
28		6222249	20/400
35		6222251	20/400
42		6222260	20/300
54		6222271	20/300



O-Ring EPDM

GROUP: I

Size	*	Code	Pcs. /packing
76,1		620801.5	5/100
88,9		620802.6	5/100
108		620803.7	5/50



* on request – (delivery time up to 4 weeks)

** availability by individual arrangements

*** till stock ends

flexible hose with straight ending

GROUP: I

Size	długość	*	Code	Pcs. /packing
Rp½"×Ø22	1000	**	619800.5S	-/10
Rp½"×Ø22	1500	**	619802.7S	-/10
Rp½"×Ø22	2000	**	619803.8S	-/10
Rp½"×Ø28	1000	**	619804.9S	-/10
Rp½"×Ø28	1500	**	619806.0S	-/10
Rp½"×Ø28	2000	**	619807.1S	-/10



flexible hose with 90° angle ending

GROUP: I

Size	długość	*	Code	Pcs. /packing
Rp½"×Ø22	800	**	619808.2S	-/10
Rp½"×Ø22	1000	**	619809.3S	-/10
Rp½"×Ø22	1500	**	619811.5S	-/10
Rp½"×Ø28	800	**	619813.7S	-/10
Rp½"×Ø28	1000	**	619814.8S	-/10
Rp½"×Ø28	1500	**	619816.1S	-/10



All flexible hoses are equipped with mounting bracket: 1 x 700 mm square pipe, 1 x sliding clamp, 2 x multiclip bracket.

cutter for steel pipes

GROUP: K

Size	*	Code	Pcs. /packing
15-54 mm		113000	any
35-108 mm		113100	any



wheel for cutter for steel pipes - service element

GROUP: K

Size	*	Code	Pcs. /packing
		341614	any



electric cutter

GROUP: K

Size	*	Code	Pcs. /packing
22-108 mm		845000	any



stripping tool - drill set

GROUP: K

Size	*	Code	Pcs. /packing
15-54 mm		113835	any



press machine ECO 301

GROUP: K

Nazwa	Dopuszczalny zakres zaciskanych średnic	Typ zasilania [V]	*	Code	Pcs. /packing
ECO 301	22-54 mm	Sieciowe 220-240		620570.5	any



* on request – (delivery time up to 4 weeks)

** availability by individual arrangements

*** till stock ends

ECO 301 press jaw

GROUP: K

Size	*	Code	Pcs. /packing
22		620575.1	any
28		620576.0	any



ECO 301 HP Snap On collar

GROUP: K

Size	*	Code	Pcs. /packing
35		634106.0	any
42		634107.1	any
28		634108.2	any



adapter ZB 303 for ECO301

GROUP: K

Diameters	*	Code	Pcs. /packing
35-42-54		634111.5	any



battery press tool ACO 401

GROUP: K

Size	*	Code	Pcs. /packing
76,1-108 mm		634008.1	any



press jaws for ACO 401

GROUP: K

Size	*	Code	Pcs. /packing
76,1		634009.2	any
88,9		634010.3	any
108		634011.4	any



* on request – (delivery time up to 4 weeks)

** availability by individual arrangements

*** till stock ends



Safety for years to come



SYSTEM **KAN-therm**

Inox Sprinkler

Technical information.
Pricelist



TECHNOLOGY OF SUCCESS



ISO 9001



Application and operational conditions

KAN-therm Inox Sprinkler System is designed for constructing pipelines (distributing or splitting conduits) of stationary air or water sprinkler systems installed in small or medium fire hazard areas (LH, OH1, OH2, OH3 and up to OH 4 - in reference to exhibition rooms, theatres and concert halls) (according to VdS CEA 4001 guidelines)

The system's pipes and fittings are approved by the CNBOP (Fire Protection Science and Research Center) with AT-1106-0249/2009 ID and VdS certificate.

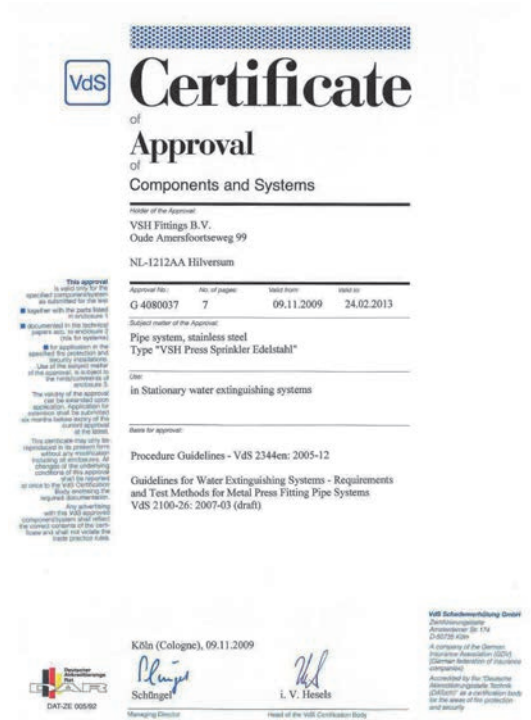

Maximum operating pressure of the pipes and fittings is

- for 22 - 76,1 diameters, 16,0 bar
- for 88,9 diameter 12,5 bar
- for 108 diameter - 10,0 bar

The installation should be designed and constructed according to guidelines included in this document, as well as with applicable standards and regulations

Designing, assembly and commissioning of the sprinkler system is defined by PN-EN 12845:2008 standard. Stationary fire extinguishing units. Automatic sprinkler units Design, assembly and maintenance

System KAN-therm Inox Sprinkler - stainless steel pipes



KAN-therm Inox Sprinkler System pipes for sprinkler systems are precise X5CrNiMo (1.4401 acc. to EN 10088 AISI 316) stainless steel pipes.

KAN-therm Inox Sprinkler System pipes may be classified as A category incombustible materials, acc. to DIN 4102, part 1.

The pipes are distributed in 6 metre lengths. Minimum pipe bend radius $3,5 \times D$ (for DN20 - DN25 diameters).

Pipe technical specification

DN	Outside diameter x wall thickness	Inside diameter [mm]	Unit mass [kg/m]	Water capacity [l/m]
	[mm × mm]			
20	22 × 1,5	19,6	0,624	0,302
25	28 × 1,5	25,6	0,790	0,515
32	35 × 1,5	32,0	1,240	0,804
40	42 × 1,5	39,0	1,503	1,195
50	54 × 1,5	51,0	1,972	2,043
65	76,1 × 2,0	72,1	3,550	4,548
80	88,9 × 2,0	84,9	4,150	5,661
100	108 × 2,0	104,0	5,050	8,495

KAN-therm Inox Sprinkler pipe for sprinkler system dimensions.

Material	X5CrNiMo stainless steel material no. 1.4401 acc. to EN 10088-2 (AISI 316)
Outside diameter tolerance	EN 10305-3
Thermal expansion coefficient	0,0160 mm/m at $\Delta T = 1K$
Minimum bend radius (for diameters up to $\varnothing 28$ mm)	3,5 x outside pipe diameter (up to $-10^{\circ}C$)
Delivery	6 m \pm 50 mm lengths
Marking	name or manufacturer label, material identification outside diameter x wall thickness, approval no., manufacture date
Max. operating pressure	16 bar (22-76,1 mm); 12,5 bar (88,9 mm); 10 bar (108 mm)

System KAN-therm Inox Sprinkler - pressed stainless steel couplings

KAN-therm Inox Sprinkler System pressed couplings are made of stainless steel, material no. 1.4404 acc. to EN 10088. The couplings are equipped with EPDM rubber sealing ring (O-ring). Coupling diameter range DN20 - DN100



System KAN-therm Inox Sprinkler - assortment

stainless steel pipe

GROUP: H

Size	*	Code	Pcs.	Packing
22×1,2		611793.6S	bar 6m	6/360
28×1,2		611794.7S	bar 6m	6/300
35×1,5		611795.8S	bar 6m	6/180
42×1,5		611796.9S	bar 6m	6/150
54×1,5		611797.1S	bar 6m	6/90
76,1×2		611798.0S	bar 6m	6/168
88,9×2		611799.1S	bar 6m	6/136
108×2		611800.2S	bar 6m	6/108



press male connector

GROUP: G

Size	l	z	*	Code	Packing
22×R1/2	42	21		6190635S	10/70
22×R3/4	43,3	22,3		6190646S	10/100
22×R1	48,5	27,5		6190624S	10/60
28×R3/4	45,2	22,2		6190679S	10/50
28×R1	48	25		6190657S	10/60
28×R1 1/4	51,5	28,5		6190668S	10/30
35×R1	52,7	26,7		6190681S	10/40
35×R1 1/4	55	29		6190701S	5/40
35×R1 1/2	56	30		6190690S	10/20
42×R1 1/4	59	29		6190723S	4/12
42×R1 1/2	59	29		6190712S	4/24
54×R1 1/2	64,7	29,7		6190734S	4/16
54×R2	69	34		6190745S	4/12
76,1×R2 1/2	125	70		620475.9S	2/-
88,9×R3	138	75		620476.1S	2/-

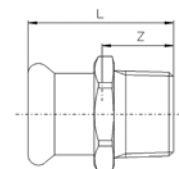

press union connector

GROUP: G

Size	l	z	*	Code	Packing.
22×R1/2	63	42		6192164S	2/40
22×R3/4	68,5	47,5		6192175S	2/40
22×R1	71,8	50,8		6192186S	2/30
28×R1	72,8	49,8		6192197S	2/30
35×R1 1/4	78,2	52,2		6192208S	2/16
42×R1 1/2	85,4	55,4		6192219S	2/12
54×R2	100	65		6192296S	2/4

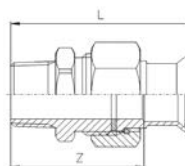

* on request – (delivery time up to 4 weeks)

** availability by individual arrangements

*** till stock ends

press female connector

GROUP: G

Size	l	z	*	Code	Packing
22×Rp½	36,5	5,5		6190461S	10/100
22×Rp¾	39,5	7,5		6190470S	10/100
22×Rp1	43,6	9,6		6190459S	10/60
28×Rp½	38	3		6193308S	10/40
28×Rp¾	40	6		6190503S	10/40
28×Rp1	44,6	8,6		6190481S	10/60
28×Rp1¼	47	9		6190492S	10/30
35×Rp1	46	7		6190514S	10/20
35×Rp1¼	50	9		6190536S	10/30
35×Rp1½	50	10		6190525S	10/20
42×Rp1¼	52	3		6190558S	4/12
42×Rp1½	54	10		6190547S	4/24
54×Rp1½	58	9		6190569S	4/12
54×Rp2	63	10		6190571S	4/12

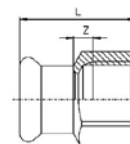

press female union connector

GROUP: G

Size	l	z	*	Code	Packing
22×Rp¾	63	25,5		6192065S	2/40
22×Rp1	65,8	25,3		6192076S	2/30
28×Rp1	65	22,5		6192087S	2/26
35×Rp1¼	73	25,3		6192098S	1/20
42×Rp1½	82	30		6192109S	2/8
54×Rp2	91	30		6192111S	2/4

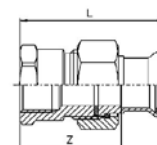

press half union connector (with flat gasket)

GROUP: G

Size	l	z	*	Code	Packing.
22×Rp¾	11	11		6191757S	10/60
22×Rp1	10	10		6191768S	10/40
28×Rp1	10	10		6191779S	4/32
35×Rp1¼	13	13		6191781S	4/12
42×Rp1½	15	15		6191790S	4/8
54×Rp2	36,7	22		6240971S	10/100

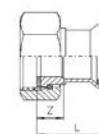

press coupling

GROUP: G

Size	l	z	*	Code	Packing
22×22	52	10		6190965S	10/80
28×28	56,2	10,2		6190976S	10/60
35×35	62,3	10,3		6190987S	5/40
42×42	73,3	13,3		6190998S	4/24
54×54	83	13		6191009S	4/16
76,1×76,1	142	32		620415.4S	4/-
88,9×88,9	163	37		620416.5S	4/-
108×108	192	38		620417.6S	4/-

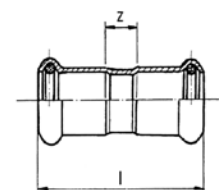

* on request – (delivery time up to 4 weeks)

** availability by individual arrangements

*** till stock ends

press slip coupling

GROUP: G

Size	l	z	*	Code	Packing
22×22	84	21		6191306S	10/60
28×28	91,2	23		6191317S	10/40
35×35	102,2	26		6191328S	5/20
42×42	120,3	30		6191339S	4/16
54×54	140	35		6191341S	2/8
76,1×76,1	230	60		620428.6S	2/-
88,9×88,9	258	70		620429.7S	2/-
108×108	305	80		620430.8S	2/-

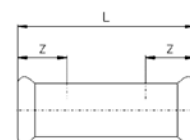

press 90° elbow

GROUP: G

Size	l	z	*	Code	Packing
22×22	51	30		6190228S	10/60
28×28	60,1	37,1		6190239S	5/30
35×35	71,1	45,1		6190241S	5/20
42×42	86,1	56,1		6190250S	2/8
54×54	105	70		6190261S	2/8
76,1×76,1	150	95		6230004S	2/-
88,9×88,9	175	112		6230015S	2/-
108×108	214	137		6230026S	1/-

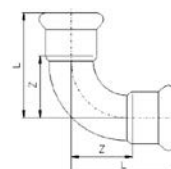

press nipple 90° elbow

GROUP: G

Size	l	z	h	*	Code	Packing
22×22	51	30	60		6190360S	5/60
28×28	60,1	37,1	65,5		6190371S	5/30
35×35	71,1	45,1	75,9		6190382S	5/10
42×42	86,1	56,1	92,5		6190393S	2/8
54×54	105	70	110,6		6190404S	2/6
76,1×76,1	150	95	165		6230037S	1/-
88,9×88,9	174	110	190		6230048S	1/-
108×108	216	137	238		6230059S	1/-

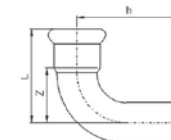

KAN-therm press 45° elbow

GROUP: G

Size	l	z	*	Code	Packing
22×22	35,2	14,2		6190063S	10/70
28×28	40,2	17,2		6190074S	10/40
35×35	46,5	20,5		6190085S	5/25
42×42	56,3	26,3		6190096S	2/16
54×54	66,9	31,9		6190107S	2/8
76,1×76,1	98	43		6230061S	2/-
88,9×88,9	112	49		6230070S	2/-
108×108	138	61		6230081S	2/-



* on request – (delivery time up to 4 weeks)

** availability by individual arrangements

*** till stock ends

press nipple 45° elbow

GROUP: G

Size	l	z	?	*	Code	Packing
22×22	35,2	14,2	?		6190131S	10/70
28×28	40,2	17,2			6190140S	10/40
35×35	46,5	20,5			6190151S	5/25
42×42	56,3	26,3			6190162S	2/16
54×54	66,9	31,9			6190173S	2/8
76,1×76,1	98	43			6230092S	2/-
88,9×88,9	112	49			6230103S	2/-
108×108	138	61			6230114S	2/-

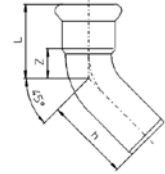

press tee

GROUP: G

Size	l1	z1	l2	z2	*	Code	Packing
22×22x22	39,5	18,5	43,5	22,5		6191405S	10/40
28×28x28	44,5	21,5	48,5	25,5		6191449S	5/25
35×35x35	51	25	55	29		6191493S	5/15
42×42x42	60	30	61,5	31,5		6191537S	4/8
54×54x54	71	36	72,5	37,5		6191581S	2/6
76,1×76,1×76,1	116	61	115	60		620431.9S	2/-
88,9×88,9×88,9	131	68	127	64		620432.1S	2/-
108×108×108	156	79	155	78		620433.0S	2/-

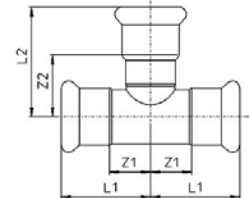

* on request – (delivery time up to 4 weeks)

** availability by individual arrangements

*** till stock ends

press tee

GROUP: G

Size	l1	z1	l2	z2	*	Code	Packing
28×22×28	46	23	45	24		6191438S	10/30
35×22×35	51	25	50	29		6191471S	5/20
35×28×35	51	25	52	29		6191482S	5/20
42×22×42	60	30	52,5	31,5		6191504S	4/12
42×28×42	60	30	54,5	31,5		6191515S	4/12
42×35×42	60	30	57,5	31,5		6191526S	4/12
54×22×54	71	36	58,5	37,5		6191548S	2/8
54×28×54	71	36	60,5	37,5		6191559S	2/8
54×35×54	71	36	63,5	37,5		6191561S	2/8
54×42×54	71	36	67,5	37,5		6191570S	2/8
76,1×22×76,1	116	61	68	45		620434.1S	2/-
76,1×28×76,1	116	61	71	47	**	620435.2S	2/-
76,1×35×76,1	116	61	75	48	**	620436.3S	2/-
76,1×42×76,1	116	61	79	47	**	620437.4S	2/-
76,1×54×76,1	116	61	80	43	**	620438.5S	2/-
88,9×22×88,9	131	68	76	53		620439.6S	2/-
88,9×28×88,9	131	68	76	52	**	620440.7S	2/-
88,9×35×88,9	131	68	83	56	**	620441.8S	2/-
88,9×42×88,9	131	68	85	53	**	620442.9S	2/-
88,9×54×88,9	131	68	93	56	**	620443.1S	2/-
88,9×76,1×88,9	131	68	116	61	**	620444.0S	2/-
108×22×108	156	79	85	62		620445.1S	2/-
108×28×108	156	79	88	64	**	620446.2S	2/-
108×35×108	156	79	94	67	**	620447.3S	2/-
108×42×108	156	79	96	64	**	620448.4S	2/-
108×54×108	156	79	102	65	**	620449.5S	2/-
108×76,1×108	156	79	125	70	**	620450.6S	2/-
108×88,9×108	156	79	135	72		620451.7S	2/-

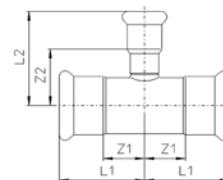

press nipple reducer

GROUP: I

Size	l	z	d1	d2	*	Code	Packing
28×22	61,2	40,2	28	22		6191174S	10/80
35×22	69	48	35	22		6191196S	5/50
35×28	68,1	45,1	35	28		6191207S	5/60
42×22	84,5	63,5	42	22		6191218S	4/24
42×28	77,9	54,9	42	28		6191229S	4/24
42×35	77,6	51,6	42	35		6191231S	4/24
54×22	96,5	75,5	54	22		6191240S	4/16
54×28	95,5	72,5	54	28		6191251S	4/16
54×35	94,6	68,6	54	35		6191262S	4/16
54×42	95,1	65,1	54	42		6191273S	4/16
76,1×42	151	119	76,1	42		620421.1S	2/-
76,1×54	140	103	76,1	54		620422.0S	2/-
88,9×54	156	119	88,9	54		620423.1S	2/-
88,9×76,1	156	101	88,9	76,1		620424.2S	2/-
108×54	204	167	108	54		620425.3S	2/-
108×76,1	196	141	108	76,1		620426.4S	2/-
108×88,9	190	127	108	88,9		620427.5S	2/-

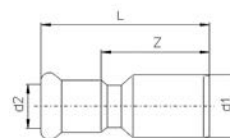

* on request – (delivery time up to 4 weeks)

** availability by individual arrangements

*** till stock ends

press male elbow

GROUP: G

Size	l2	l1	z	*	Code	Packing
22×Rp¾	48,5	27,5	38,5		6190899S	10/60
28×R1	53	30	46		6190901S	10/30
35×R1¼	60	34	52		6190910S	5/20
42×R1½	69	39	58		6190921S	2/16
54×R2	82	47	68		6190932S	2/8

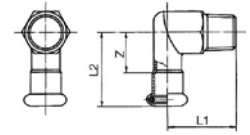

press female elbow

GROUP: G

Size	l2	z2	l1	z1	*	Code	Packing
22×R1½	45	24	31	16		6198456S	10/50
22×Rp¾	48,5	27,5	33	16,7		6190844S	10/50
28×R1½	47,5	24,5	35	16		6198467S	10/30
28×Rp¾	50,5	27,5	35	18,5		6198478S	10/30
28×Rp1	54,5	31,5	37	17,5		6190855S	10/30
35×Rp1½	56	30	35	20		6198489S	5/10
35×Rp¾	57,5	31,5	37	21		6198491S	5/10
35×Rp1	58	32	40,5	21		6198500S	5/10
35×Rp1¼	62	36	42,2	20,5		6190866S	5/10

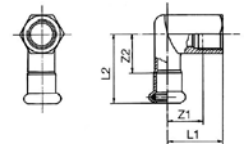

press female tee

GROUP: G

Size	l1	z1	l2	z2	*	Code	Packing
22×Rp½×22	39,5	18,5	38	22		6191625S	10/40
22×Rp¾×22	39,5	18,5	41	23		6191636S	10/40
28×Rp½×28	44,5	21,5	42	25		6191647S	5/30
28×Rp¾×28	44,5	21,5	44	26		6191658S	10/30
28×Rp1×28	44,5	21,5	46	27,5		6198599S	10/30
35×Rp½×35	51	25	45,5	28,5		6191669S	5/20
35×Rp¾×35	51	25	47,5	29,5		6191671S	5/20
35×Rp1×35	51	25	50	31		6198601S	5/20
42×Rp½×42	60	30	48	31		6191680S	4/16
42×Rp¾×42	60	30	50	32		6191691S	4/12
42×Rp1×42	60	30	52,5	33,5		6198610S	4/12
54×Rp½×54	71	36	54	37		6191702S	2/8
54×Rp¾×54	71	36	56	38		6191724S	2/8
54×Rp1×54	71	36	58	39		6198621S	2/8
54×Rp2×54	71	36	64,7	46,7		6191713S	2/6
76,1×Rp¾×76,1	116	55	68	55		620452.8S	2/-
76,1×Rp2×76,1	116	55	81	59		620455.0S	2/-
88,9×Rp¾×88,9	131	63	87	74		620453.9S	2/-
88,9×Rp2×88,9	131	63	88	66		620456.1S	2/-
108×Rp¾×108	156	77	86	73		620454.1S	2/-
108×Rp2×108	156	77	98	76		620457.2S	2/-

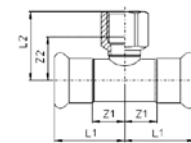

* on request – (delivery time up to 4 weeks)

** availability by individual arrangements

*** till stock ends

press short wallplate elbow

GROUP: G

Size	d	l1	z1	a	z2	c	*	Code	Packing
22×Rp¾ - long	5,5	48,5	27,5	40	16,7	64		6192010S	10/40
22×Rp¾ - short	5,5	49	28	40	13	52		6191823S	10/50

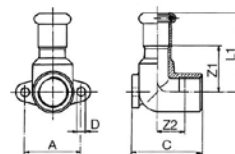

press cup

GROUP: G

Size	l	z	*	Code	Packing
22	24,1	3,1		6191031S	10/150
28	26,1	3,1		6191042S	10/130
35	29,1	3,1		6191053S	5/75
42	36,1	6,6		6191064S	4/48
54	41,6	6,6		6191075S	4/24
76,1	95	40		620418.7S	4/-
88,9	107	44		620419.8S	4/-
108	127	50		620420.9S	4/-

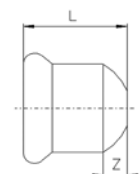

crossover

GROUP: G

Size	a	b	l	*	Code	Packing
22×22	178	44	65			10/50
28×28	210	50	74			10/20

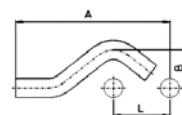

bend 15°

GROUP: G

Size	h2	h2min	h1	h1min	*	Code	Packing
28×28	134	45	45	45		6190008S	10/40
35×35	222	53	73	53		6190019S	5/15
42×42	280	59	89	59		6191834S	2/20
54×54	337	67	122	67		6191845S	2/10

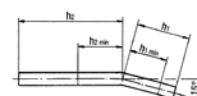

bend 30°

GROUP: G

Size	h2	h2min	h1	h1min	*	Code	Packing
28×28	130	51	51	51		6190021S	10/40
35×35	214	60	73	60		6190030S	4/12
42×42	272	69	99	69		6191856S	2/20
54×54	326	79	134	79		6191867S	2/8

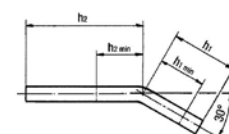

* on request – (delivery time up to 4 weeks)

** availability by individual arrangements

*** till stock ends

bend 60°

GROUP: G

Size	h2	h2min	h1	h1min	*	Code	Packing
28×28	121	63	63	63		6190184S	5/30
35×35	203	77	97	77		6190195S	4/12
42×42	256	90	120	90		6191878S	5/5
54×54	306	107	162	107		6191889S	2/6

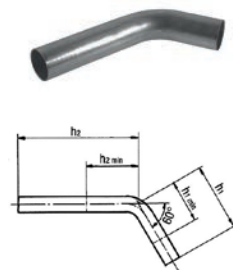

bend 90°

GROUP: G

Size	h2	h2min	h1	h1min	*	Code	Packing	
22×22	120	70	72	70		6190294S	10/30	31,72
28×28	120	80	82	80		6190305S	5/20	33,60
35×35	200	100	120	100		6190316S	4/8	69,13
42×42	250	120	150	120		6190327S	2/4	85,24
54×54	300	145	200	145		6190338S	2/2	106,87

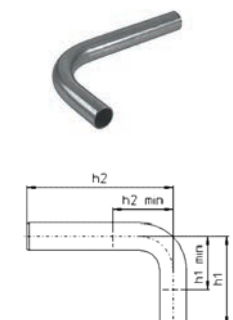

press flange PN16

GROUP: G

Size	z	d	h	k	b	d2	otwory	*	Code	Packing
22	42,5	105	63,5	75	12	14	4		6190778S	1/12
28	48	115	71	85	14	14	4		6190789S	1/12
35	53	140	79	100	15	18	4		6190791S	1/6
42	61	150	91	110	16	18	4		6190800S	1/4
54	77	165	112	125	18	18	4		6190811S	1/2
76,1	71	185	126	145	18	18	4		620412.1S	4/-
88,9	84	200	147	160	20	18	8		620413.2S	2/-
108	90	220	167	180	20	18	8		620414.3S	2/-

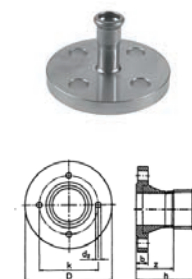

KAN-therm press flange connector

GROUP: G

Size	l	z	b	*	Code	Packing
22×1¼	28	7	38,8		6191933S	20/80
22×1½	28	7	44,4		6191944S	20/80
28×1½	30,5	7,5	44,4		6191955S	20/80
35×2	33	7	56		6191966S	10/30
42×2¼	37	7	62		6191977S	10/30
54×2¾	44	9	77,6		6191988S	5/20



* on request – (delivery time up to 4 weeks)

** availability by individual arrangements

*** till stock ends

groove connector

GROUP: G

Size	l	D	Z	*	Code	Packing
28×33,7	72,5	33,7	26	**	619855.5S	10/30
35×42,4	81	42,4	26	**	619856.6S	10/30
42×48,3	86	48,3	26	**	619857.7S	5/20
54×60,3	96,5	60,3	26	**	619858.8S	5/15
76,1×76,1	90	76,1	36,0	**	6193319S	2/-
88,9×88,9	100	88,9	36,0	**	6193321S	2/-
108×114	110	114,3	36,0	**	6193330S	2/-



long press female connector

GROUP: I

Size	A	B	C	L	*	Code	Packing
22×Rp½	92	25	15	40	**	619851.1S	10/60
22×Rp¾	97	25	16	40	**	619852.2S	10/60
28×Rp½	94	30	15	40	**	619853.3S	10/40
28×Rp¾	93	30	16	40	**	619854.4S	10/40



O-Ring LBP EPDM

GROUP: I

Size	*	Code	Packing
22	**	6222238	20/500
28	**	6222249	20/400
35	**	6222251	20/400
42	**	6222260	20/300
54	**	6222271	20/300



O-Ring EPDM

GROUP: I

Size	*	Code	Packing
76,1	**	620801.5	5/100
88,9	**	620802.6	5/100
108	**	620803.7	5/50



flexible hose with straight ending

GROUP: I

Size	długość	*	Code	Packing
Rp½"×Ø22	1000	**	619800.5S	-/10
Rp½"×Ø22	1500	**	619802.7S	-/10
Rp½"×Ø22	2000	**	619803.8S	-/10
Rp½"×Ø28	1000	**	619804.9S	-/10
Rp½"×Ø28	1500	**	619806.0S	-/10
Rp½"×Ø28	2000	**	619807.1S	-/10



All flexible hoses are equipped with mounting bracket: 1 x 700 mm square pipe, 1 x sliding clamp, 2 x multclip bracket

* on request – (delivery time up to 4 weeks)

** availability by individual arrangements

*** till stock ends

KAN-therm flexible hose with 90° angle ending

GROUP: I

Size	dlugość	*	Code	Packing
Rp½"×Ø22	800	**	619808.2S	-/10
Rp½"×Ø22	1000	**	619809.3S	-/10
Rp½"×Ø22	1500	**	619811.5S	-/10
Rp½"×Ø28	800	**	619813.7S	-/10
Rp½"×Ø28	1000	**	619814.8S	-/10
Rp½"×Ø28	1500	**	619816.1S	-/10

All flexible hoses are equipped with mounting bracket: 1 x 700 mm square pipe, 1 x sliding clamp, 2 x multclip bracket



cutter for steel pipes

GROUP: K

Size	*	Code	Packing
15-54 mm		113000	any
35-108 mm		113100	any



wheel for cutter for steel pipes - service element

GROUP: K

Size	*	Code	Packing
		341614	any



wheel for electric cutter for steel pipes - service element

GROUP: K

Size	*	Code	Packing
22-108 mm		845000	any



stripping tool - drill set

GROUP: K

Size	*	Code	Packing
15-54 mm		113835	any



press machine ECO 301

GROUP: K

Name	Diameters	Voltage	*	Code	Packing
ECO 301	22-54 mm	220-240		620570.5	any



pressing jaw for ECO301

GROUP: K

Size	*	Code	Packing
22		620575.1	any
28		620576.0	any

Caution:
collars 35 – 54 mm needs additional adapter ZB 303.



* on request – (delivery time up to 4 weeks)

** availability by individual arrangements

*** till stock ends

press collar HP Snap On for ECO 301

GROUP: K

Size	*	Code	Packing
35		634106.0	1
42		634107.1	1
54		634108.2	1

Caution:
collars 35 – 54 mm needs additional adapter ZB 303.



adapter ZB 303 for ECO301

GROUP: K

Size	*	Code	Packing
35-42-54		634111.5	any



battery press tool ACO 401

GROUP: K

Size	*	Code	Packing
76,1-108 mm		634008.1	any



press jaws for ACO 401

GROUP: K

Size	*	Code	Packing
76,1		634009.2	any
88,9		634010.3	any
108		634011.4	any



* on request – (delivery time up to 4 weeks)

** availability by individual arrangements

*** till stock ends

Index

6241114S	24	6240454S	26	6340983S	28	624130.1S	31	6190657S	40
6241125S	24	6208061S	26	6340994S	28	624134.5S	31	6190668S	40
6241136S	24	6208070S	26	6341005S	28	624135.6S	31	6190681S	40
6241147S	24	6208081S	26	6341016S	28	624136.7S	31	6190701S	40
6241158S	24	6240511S	26	6341027S	28	6340774S	31	6190690S	40
6241378S	24	6240520S	26	6240234S	28	6340785S	31	6190723S	40
6241389S	24	6240531S	26	6240245S	28	6340796S	31	6190712S	40
6241391S	24	6240542S	26	6240256S	28	624131.2S	31	6190734S	40
6241015S	24	6240553S	26	6246651S	28	624132.3S	31	6190745S	40
6240135S	24	6208125S	26	6240267S	28	624126.8S	31	620475.9S	40
6241026S	24	6208136S	26	6240278S	28	624127.9S	31	620476.1S	40
6249852S	24	6208147S	26	6240289S	28	6222238	31	6192164S	40
6240146S	24	6240465S	26	6240291S	28	6222249	31	6192175S	40
6341247S	24	6240476S	26	6240300S	28	6222251	31	6192186S	40
6240157S	24	6240487S	26	6240993S	28	6222260	31	6192197S	40
6240168S	24	6240498S	26	6206387S	28	6222271	31	6192208S	40
6240179S	24	6240509S	26	6206398S	28	620801.5	31	6192219S	40
6302823S	24	6208092S	26	6206409S	28	620802.6	31	6192296S	40
6302825S	24	6208103S	26	6206411S	28	620803.7	31	6190461S	41
6240916S	24	6208114S	26	6206420S	28	619800.5S	32	6190470S	41
6240927S	24	6240564S	27	6206431S	28	619802.7S	32	6190459S	41
6240938S	24	6240575S	27	6240366S	29	619803.8S	32	6193308S	41
6240949S	24	6240586S	27	6240377S	29	619804.9S	32	6190503S	41
6240951S	24	6240597S	27	6240388S	29	619806.0S	32	6190481S	41
6340554S	24	6240608S	27	6240399S	29	619807.1S	32	6190492S	41
6340565S	24	6206442S	27	6240401S	29	619808.2S	32	6190514S	41
6340576S	24	6206453S	27	6240982S	29	619809.3S	32	6190536S	41
6340587S	24	6206464S	27	6249577S	29	619811.5S	32	6190525S	41
6340598S	24	6240718S	27	6240964S	29	619813.7S	32	6190558S	41
6240960S	25	6240729S	27	6241169S	29	619814.8S	32	6190547S	41
6240971S	25	6240731S	27	6241171S	29	619816.1S	32	6190569S	41
6240003S	25	6240740S	27	6249588S	29	113000	32	6190571S	41
6240014S	25	6240751S	27	6241180S	29	113100	32	6192065S	41
6240025S	25	6240762S	27	6241061S	29	341614	32	6192076S	41
6240036S	25	6240773S	27	6249599S	29	845000	32	6192087S	41
6240047S	25	6240784S	27	6340972S	29	113835	32	6192098S	41
6206200S	25	6240795S	27	159,22	29	620570.5	32	6192109S	41
6206211S	25	6240806S	27	6340983S	29	620575.1	33	6192111S	41
6206222S	25	6240817S	27	201,06	29	620576.0	33	6191757S	41
6240058S	25	6303371S	27	6340994S	29	634106.0	33	6191768S	41
6240069S	25	6303373S	27	230,48	29	634107.1	33	6191779S	41
6240071S	25	6303375S	27	6240883S	30	634108.2	33	6191781S	41
6240080S	25	6303377S	27	6240894S	30	634111.5	33	6191790S	41
6240091S	25	6206475S	27	6240839S	30	634008.1	33	6240971S	41
6206233S	25	6303379S	27	6240841S	30	634009.2	33	6190965S	41
6206244S	25	6303381S	27	6240850S	30	634010.3	33	6190976S	41
6206255S	25	6303383S	27	6240861S	30	634011.4	33	6190987S	41
6240181S	26	6303385S	27	6240872S	30	611793.6S	40	6190998S	41
6240190S	26	6303387S	27	620659.6S	30	611794.7S	40	6191009S	41
6240201S	26	6206486S	27	620660.7S	30	611795.8S	40	620415.4S	41
6240212S	26	6303389S	27	620661.8S	30	611796.9S	40	620416.5S	41
6240223S	26	6303391S	27	6240311S	31	611797.1S	40	620417.6S	41
6208004S	26	6303393S	27	6240322S	31	611798.0S	40	6191306S	42
6208048S	26	6303395S	27	6240333S	31	611799.1S	40	6191317S	42
6208059S	26	6303397S	27	6240344S	31	611800.2S	40	6191328S	42
6240410S	26	6303399S	27	6240355S	31	6190635S	40	6191339S	42
6240421S	26	6206497S	27	6206915S	31	6190646S	40	6191341S	42
6240432S	26	6240828S	28	6206926S	31	6190624S	40	620428.6S	42
6240443S	26	6340972S	28	6206937S	31	6190679S	40	620429.7S	42

620430.8S	42	620444.0S	44	6191823S	46	619803.8S	48
6190228S	42	620445.1S	44	6191031S	46	619804.9S	48
6190239S	42	620446.2S	44	6191042S	46	619806.0S	48
6190241S	42	620447.3S	44	6191053S	46	619807.1S	48
6190250S	42	620448.4S	44	6191064S	46	619808.2S	49
6190261S	42	620449.5S	44	6191075S	46	619809.3S	49
6230004S	42	620450.6S	44	620418.7S	46	619811.5S	49
6230015S	42	620451.7S	44	620419.8S	46	619813.7S	49
6230026S	42	6191174S	44	620420.9S	46	619814.8S	49
6190360S	42	6191196S	44	6190008S	46	619816.1S	49
6190371S	42	6191207S	44	6190019S	46	113000	49
6190382S	42	6191218S	44	6191834S	46	113100	49
6190393S	42	6191229S	44	6191845S	46	341614	49
6190404S	42	6191231S	44	6190021S	46	845000	49
6230037S	42	6191240S	44	6190030S	46	113835	49
6230048S	42	6191251S	44	6191856S	46	620570.5	49
6230059S	42	6191262S	44	6191867S	46	620575.1	49
6190063S	42	6191273S	44	6190184S	47	620576.0	49
6190074S	42	620421.1S	44	6190195S	47	634106.0	50
6190085S	42	620422.0S	44	6191878S	47	634107.1	50
6190096S	42	620423.1S	44	6191889S	47	634108.2	50
6190107S	42	620424.2S	44	6190294S	47	634111.5	50
6230061S	42	620425.3S	44	6190305S	47	634008.1	50
6230070S	42	620426.4S	44	6190316S	47	634009.2	50
6230081S	42	620427.5S	44	6190327S	47	634010.3	50
6190131S	43	6190899S	45	6190338S	47	634011.4	50
6190140S	43	6190901S	45	6190778S	47		
6190151S	43	6190910S	45	6190789S	47		
6190162S	43	6190921S	45	6190791S	47		
6190173S	43	6190932S	45	6190800S	47		
6230092S	43	6198456S	45	6190811S	47		
6230103S	43	6190844S	45	620412.1S	47		
6230114S	43	6198467S	45	620413.2S	47		
6191405S	43	6198478S	45	620414.3S	47		
6191449S	43	6190855S	45	6191933S	47		
6191493S	43	6198489S	45	6191944S	47		
6191537S	43	6198491S	45	6191955S	47		
6191581S	43	6198500S	45	6191966S	47		
620431.9S	43	6190866S	45	6191977S	47		
620432.1S	43	6191625S	45	6191988S	47		
620433.0S	43	6191636S	45	619855.5S	48		
6191438S	44	6191647S	45	619856.6S	48		
6191471S	44	6191658S	45	619857.7S	48		
6191482S	44	6198599S	45	619858.8S	48		
6191504S	44	6191669S	45	6193319S	48		
6191515S	44	6191671S	45	6193321S	48		
6191526S	44	6198601S	45	6193330S	48		
6191548S	44	6191680S	45	619851.1S	48		
6191559S	44	6191691S	45	619852.2S	48		
6191561S	44	6198610S	45	619853.3S	48		
6191570S	44	6191702S	45	619854.4S	48		
620434.1S	44	6191724S	45	6222238	48		
620435.2S	44	6198621S	45	6222249	48		
620436.3S	44	6191713S	45	6222251	48		
620437.4S	44	620452.8S	45	6222260	48		
620438.5S	44	620455.0S	45	6222271	48		
620439.6S	44	620453.9S	45	620801.5	48		
620440.7S	44	620456.1S	45	620802.6	48		
620441.8S	44	620454.1S	45	620803.7	48		
620442.9S	44	620457.2S	45	619800.5S	48		
620443.1S	44	6192010S	46	619802.7S	48		



REPRESENTATIVE OFFICE
 PRODUCTION





TECHNICAL SALES REPRESENTATIVE

EXPORT WAREHOUSE

SYSTEM **KAN-therm**

Optimal, complete multipurpose installation system consisting of state of the art, mutually complementary technical solutions for pipe water distribution installations, heating installations, as well as technological and fire extinguishing installations.

It is the materialization of a vision of a universal system, the fruit of extensive experience, the passion of KAN's constructors, strict quality control of our materials and final products, and vast knowledge of the market of installations to meet the requirements of energy efficient, sustainable construction.

	Push Platinum	
	Push	
	Press LBP	
	PP	
	Steel	
	Inox	
	Sprinkler	
	Underfloor heating and automation	
	Football Stadium installations	
	Cabinets and manifolds	



KAN Sp. z o.o.
ul. Zdrojowa 51, 16-001 Białystok-Kleosin
tel. +48 85 74 99 200, fax +48 85 74 99 201
e-mail: kan@kan-therm.com

www.kan-therm.com